

XT II™ 27

Chemicals
Equipment
Programs
Process



27" High Performance Battery Burnisher • Exclusive Computer Controlled Technology

The next generation of battery burnisher! The XT II™ utilizes new state-of-the-art technologies to outperform traditional battery and propane burnishers. A precision onboard computer controller is synchronized with a powerful maintenance free motor to deliver the high level burnish response today's high speed floor finishes demand. Featuring easy-to-use controls and a "smart" watering system, the XT II™ is user friendly and increases productivity.

Applications

- Dry burnishing
- Restorative burnishing

Features

- Performance of a propane (Without the safety concerns and high maintenance costs)
- Onboard computer controller (Provides constant speed and torque)
- Maintenance free motor (No carbon brushes to replace)
- Smart watering system (For safer and easier battery maintenance)
- Easy-to-use controls (Requires less training; increases productivity)



Easy-to-use controls

Warranty

3 Year*

*Please refer to Betco Equipment Price/Product Guide for complete equipment warranty information.

Specifications

Burnish path.....	27"
Pad size	27"
Motor	Maintenance free, rated at 5 hp
Computer controller	Onboard, provides constant speed and torque
Pad pressure.....	60 lbs.
Pad speed	7,074 fpm, measured at outer diameter of pad
RPM.....	Approx. 1500
Pad driver	Exclusive Flex Lock III
Pad center lock	Threaded, for easy installation
Noise level.....	71 dB
Volts	36-volt system
Batteries	(6) 6-volt
Battery maintenance	Smart watering system
Run time.....	3 - 3.5 hours
Battery charger.....	Included
Rear charger port.....	Yes
Battery gauge	Yes
Key switch	Yes
Main power light.....	Yes, red
Length	61"
Width	29"
Height	44"
Weight	552 lbs.
Wheels.....	(2) 6" heavy duty non-marking
Casters	(2) 3" heavy duty non-marking
Productivity.....	36,000 sq. ft./hour

Available In

XT II™ 27 – 27" Battery Burnisher: Item #E12347-00

Literature Item #E12347-92

XT II™

*Fast, Powerful
Battery Burnisher.*

**Re-Charge
Your Floor
Maintenance!**

BETCO®

THE NEXT GENERATION!



- *Outperforms traditional battery burnishers.*
- *Safer, quieter and less costly than propane burnishers.*
- *Perfect for any facility.*

XT II™

High Performance Battery Burnishers • Computer Controlled Technology

The next generation of high speed burnishers! Utilizing new state-of-the-art technologies, the XT II™ battery burnishers outperform traditional battery and propane burnishers every time. A precision onboard computer controller is synchronized with a powerful maintenance-free motor to deliver the high level burnish response demanded by today's high speed floor finishes.



Low Profile Design



User Friendly Controls



Smart Watering System

Features and Benefits

- Computer controller delivers consistent performance.
- Safer and more cost effective than propane burnishers.
- High productivity results up to 36,000 sq. ft./hour.
- User-friendly controls. Easy to train and operate.
- Low 71 dB noise level.
- Maintenance-free high power motor and smart watering system for batteries.
- Low profile design allows burnishing in tight areas.
- Available in 21" and 27" models.

Outperforms Traditional Battery Burnishers

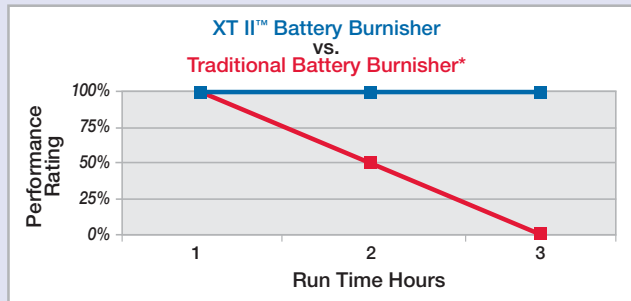

More Cost Effective than Propane Burnishers

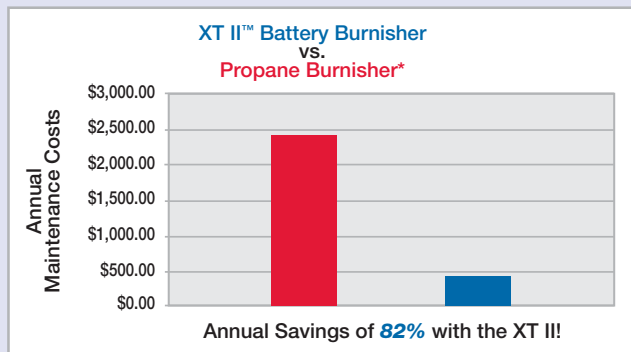

* This information is presented based on our research which we believe to be correct and objective. No guarantee is expressed or implied.

POWERBUFF®

XT II™ 27 – 27" Battery Burnisher

Item #E12347-00

Operator's Manual
Parts Schematic



Chemicals
Equipment
Programs
Process

BETCO®



XT-27

THREE YEAR LIMITED WARRANTY

PowerBuff, Inc. warrants new machines to be free from defects in material and workmanship under normal use and service to the original purchaser. This warranty period is subject to the conditions stated below.

BATTERY AND BATTERY CHARGER WARRANTIES

Battery warranty is for one year on a pro rated basis. Battery warranty is void if the batteries are not maintained at the proper level. Battery charger is warranted for one year.

EXCLUSIONS

This warranty does not cover normal wear and maintenance items including, but not limited to: belts, gaskets, wheels, casters, and routine adjustments. This warranty does not cover damage or failure which is the result of misuse, negligent operation, handling or repair, or which is the result of modification or repair by any person other than an authorized PowerBuff, Inc. service representative.

LIMITATIONS

STATED WARRANTIES ARE IN LIEU OF ALL OTHER WARRANTIES, EXPRESSED OR IMPLIED. PowerBuff's liability under this warranty is limited to repair of the product and/or replacement parts and is given to purchaser in lieu of all other remedies, including incidental and consequential damages.

WARRANTY DETAIL AND CLAIM PROCEDURES

PowerBuff, Inc. warrants to buyer that for the applicable shipment, such material will be free from defects in material and workmanship or failure to meet specifications, (a defect) appears in the material; then seller will, at its option, either repair or replace the defective goods without charge or credit or refund the purchase price of the defective material, provided that:

- 1) The defect appears within the applicable warranty period.
- 2) Buyer notifies seller in writing of the claimed defect promptly after buyer knows or reasonable should know of the claimed defect.
- 3) Seller's examination of the material discloses that the claimed defect actually exists.

Buyer shall follow seller's instruction regarding return of defective material, and no material will be accepted for repair, replacement, credit, or refund without the written authorization of and in accordance with seller's instructions. In the case of any such return, buyer shall bear the risk of in-transit loss or damage; and shall prepay all transportation charges to seller. Repaired or replacement material will be shipped prepaid by seller, and buyer shall bear the risk of in-transit loss or damage. The replaced material shall become the seller's property.







PowerBuff, Inc. * Phone 800-523-2833 * Stoneville, NC

XT-27 GENERATION II

Specifications

ITEM	Description / information
Power Supply.....	36 Volt (6 - 6Volt Batteries) 650 Cycle life
Charger.....	36 Volt - 20 Amp
Motor.....	High Horsepower, - maintenance free
Controller.....	Computer controlled
Run Time.....	3 - 3.5 Hours at constant speed & torque
Productivity.....	36,000 Square feet/hour
Wheels.....	Colson 6" Wheels - non marking
Caster.....	Duel 3" casters
Smart Watering System	Millennium 18 cell w/regulator & connectors
Pad Driver.....	Powerbuff Exclusive "Flex Loc" 27"
Pad speed.....	7,074 FPM Constant
Weight.....	552 lbs
Dimensions.....	61" Length 29" Width 44" Height
Warranty.....	Three Year Limited

SAFETY INSTRUCTIONS

<u>Hazard Level</u>	<u>Explanation or Description of Hazard Level</u>
	Failure to follow safety instructions labeled  could result in severe injury or death to the machine operator or others.
	Failure to follow safety instructions labeled  could result in injury to the machine operator or others. Also, machine or property damage could occur.
	Failure to follow safety instructions labeled  could result in damage to the machine or damage to other property.



This manual contains important information about your machine. Read and understand all instructions before operating the machine. Failure to read and follow the instructions could result in injury to the person operating the machine or injury to others. Damage to the machine or other property could occur if instructions are not followed.



Do not operate this machine around any solvents, thinners, or other flammable liquids or materials. Electrical sparks can cause a fire or even an explosion.



Do not smoke around the machine. Also, keep all sparks and flames away from the batteries. The batteries generate gases that can cause an explosion.



Special care needs to be used when working on or near the batteries. Wear eye protection. Do not lay tools on batteries, as they may short out battery terminals. Do not wear metal jewelry, as it may short out battery terminals.



Charging batteries can be dangerous. Be aware that the battery charger may have a relatively low voltage output, but the current output is very high and therefore dangerous. Do not operate the charger if any parts of the charger or charger cords are damaged. Do not stand on a wet floor when connecting or disconnecting charger to the power outlet or to the machine.

Safety Instructions are continued on the next page 

SAFETY INSTRUCTIONS (continued from previous page)



Battery acid is dangerous. Wear eye and face protection, hand protection, and body protection when working on and around batteries. If you get acid on your skin, wash off immediately. If you get acid on your clothing, remove clothing and wash any skin that was in contact with the clothing. Baking soda mixed with water will help to neutralize the acid on your skin.



The machine is very heavy, so be very careful when loading, transporting, and unloading the machine.



Keep all body parts, clothing, and objects away from moving parts.



Operate machine from the rear, not from the side.



Disconnect a wire to the batteries before working on the machine.



Do not operate machine with charger plugged in.



Do not operate machine with any parts damaged or missing.



Do not operate close to stairs, loading docks, or other drop-offs. Do not park machine in such a manner that it could roll, forward or backward, off a drop-off.



Authorized personnel must perform maintenance and repairs. Do not alter or modify the machine, unless authorized by the manufacturer.



Do not expose the electrical components to water or excessive moisture.



Always put caution signs around the areas that are being cleaned.



Do not use machine as a "ladder". Do not use machine as a "forklift" to push stuff around. Do not ride or let anyone ride on the machine.



Your machine warranty may be voided if parts other than PowerBuff parts are used.

XT27 GENERATION II

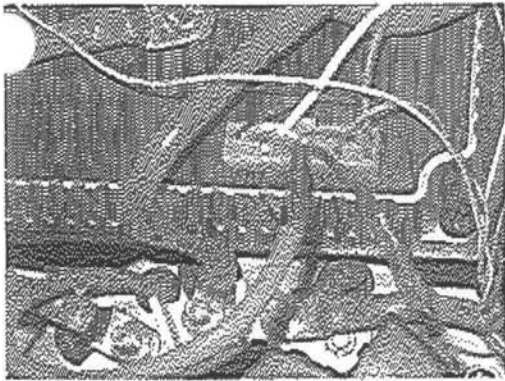

- 1: to solenoid A (+) Blue
- 3: to safety switch Green
- 8: to solenoid B (-) Yellow

- MOTOR**
- Hall Sensor Cable
- 12: Red (+)
 - 17: White
 - 18: Green
 - 19: Blue
 - 20: Black (-)

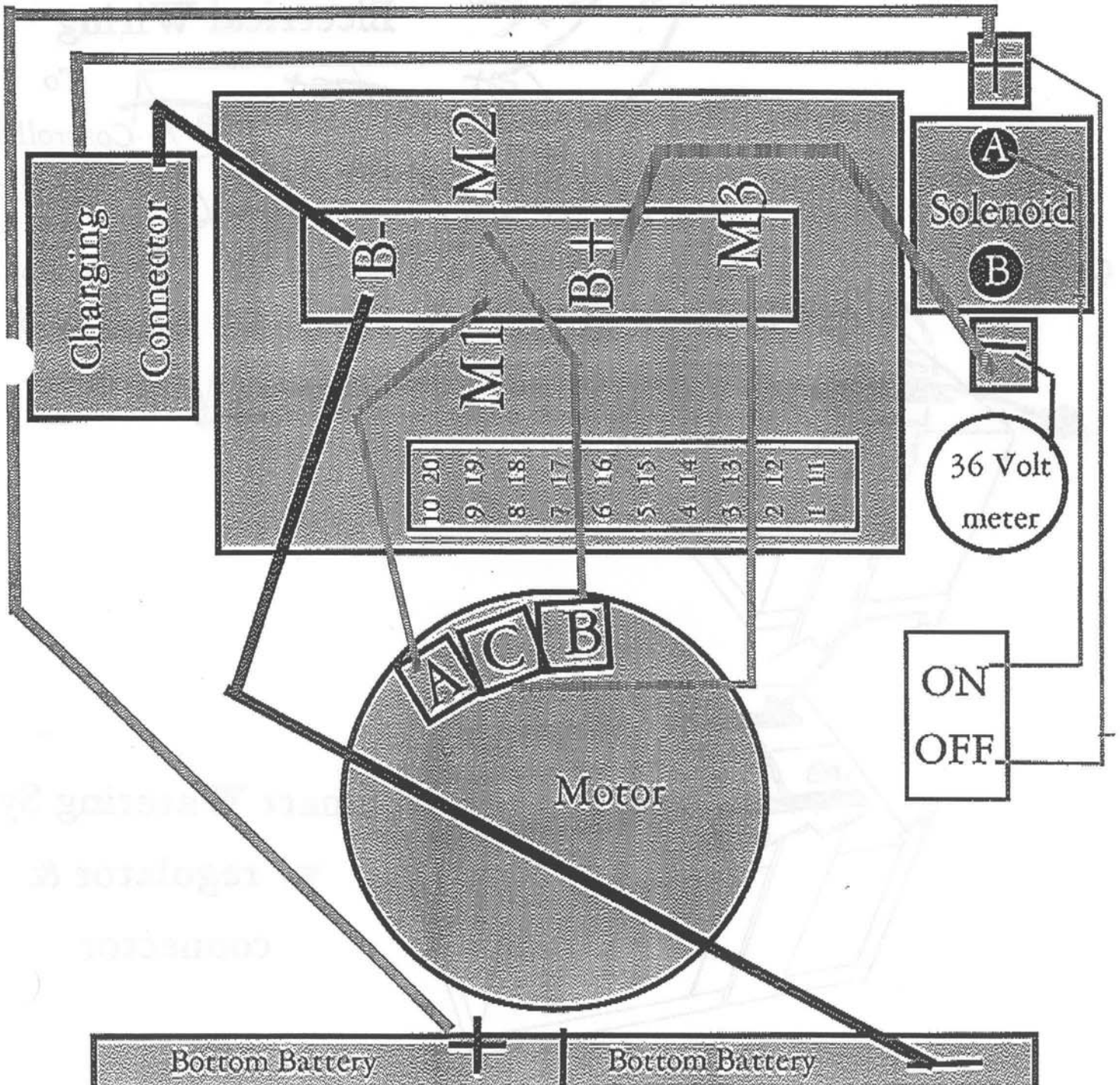

fan - 12V req'd

36 Volt

Electrical Wiring

To
Controller
B- position
To
Solenoid (+)

Hose
Connector

Smart Watering Sys
w/ regulator &
connector

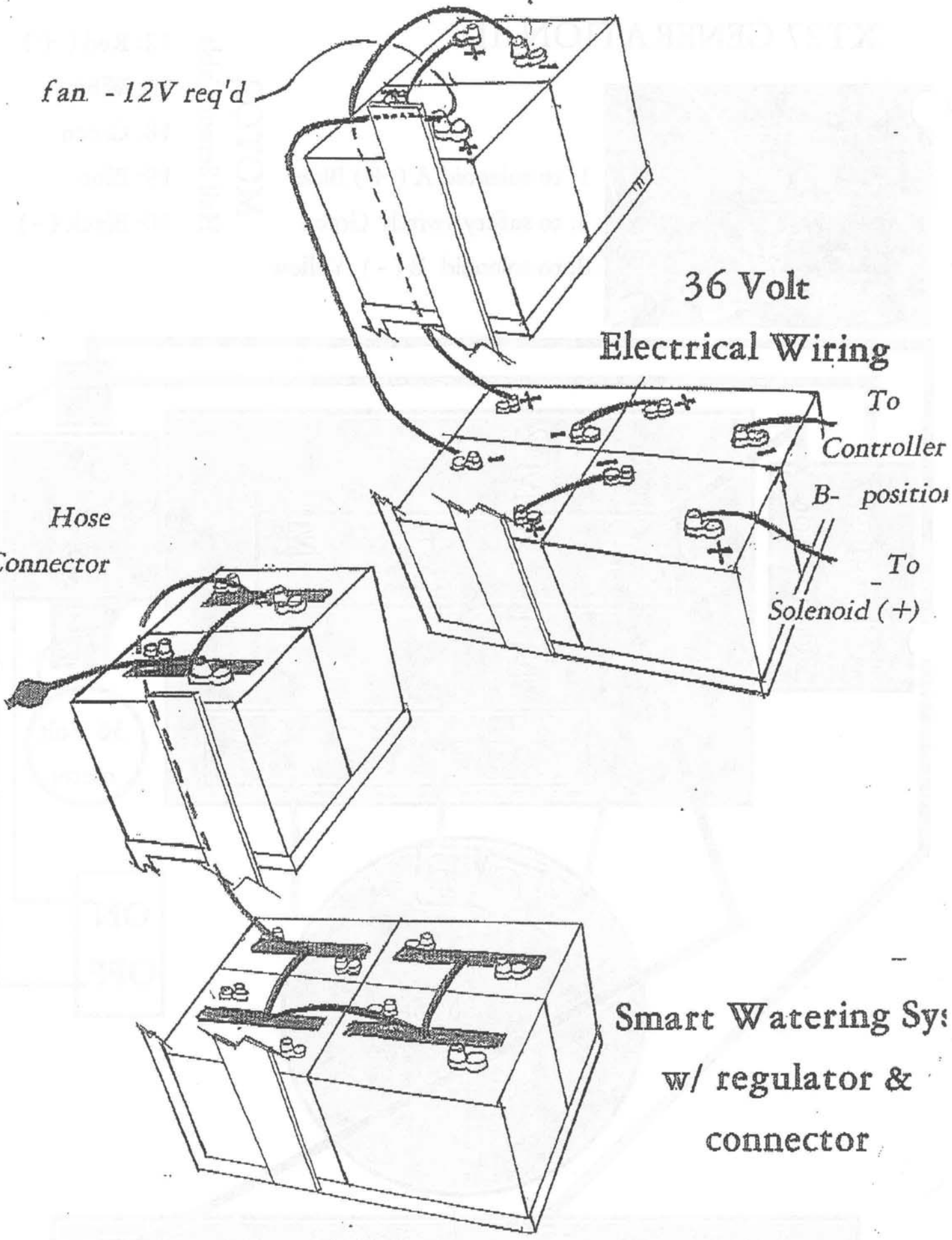

Inside back cover

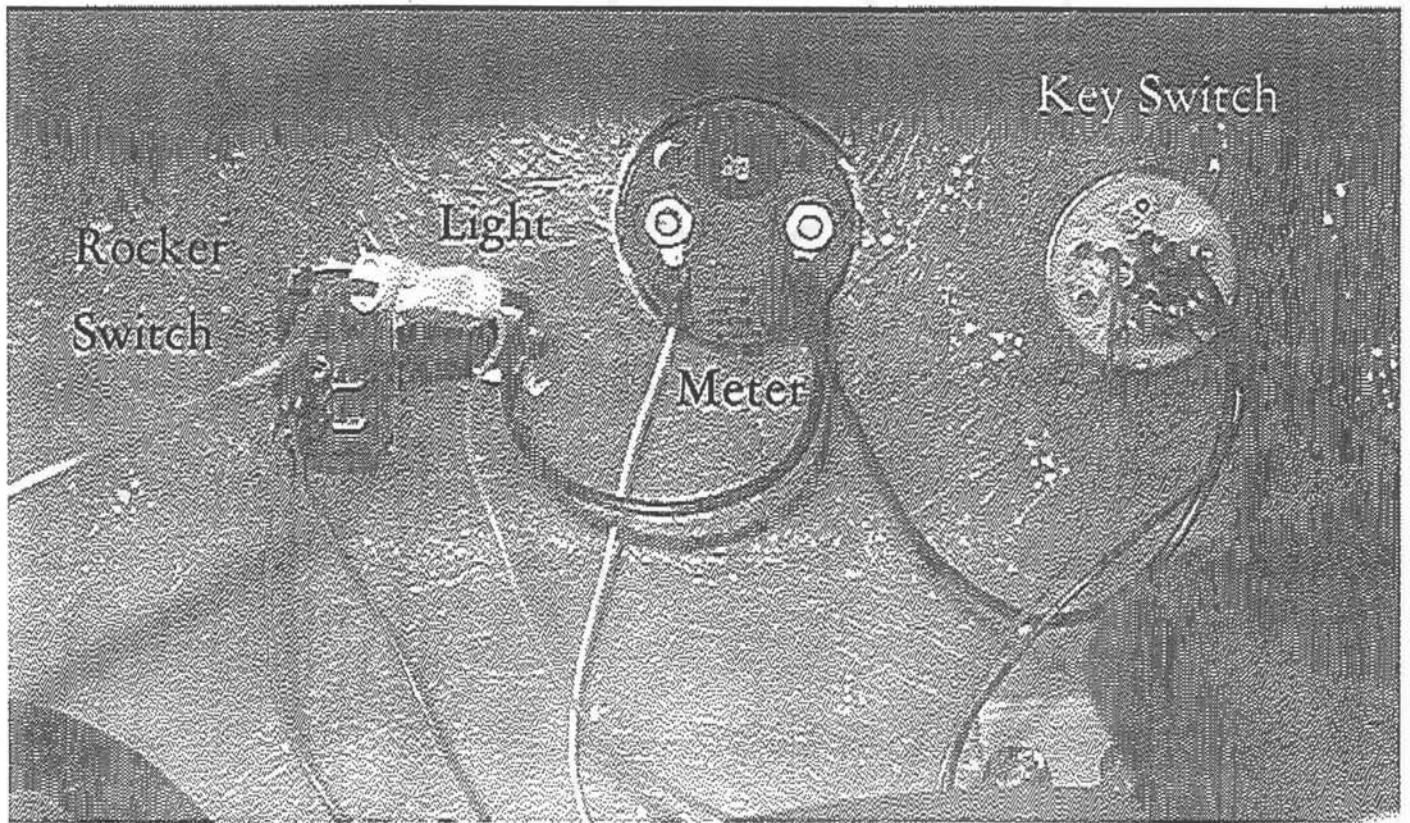

XT27 Generation II

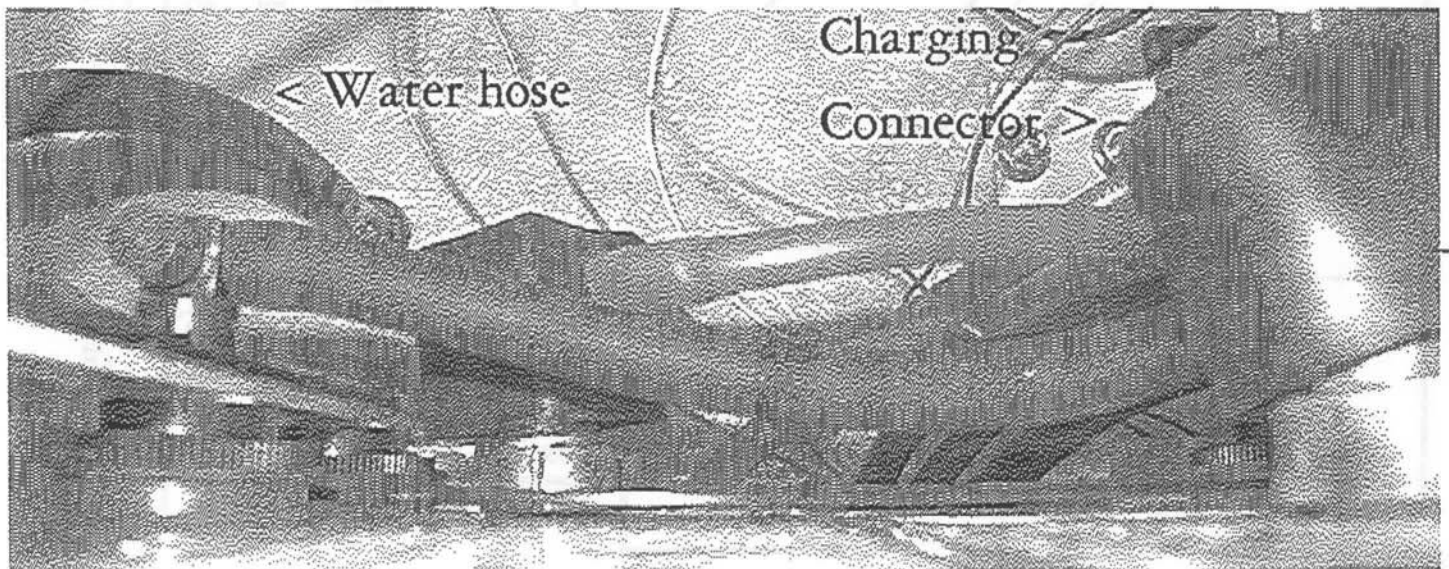

BATTERY MAINTENANCE

- To receive the longest life from the batteries, charge them when they have between 25% and 50% of a full charge.
- Do not allow batteries to remain in a discharged state for very long, as this shortens the total battery life.
- Be aware that a discharged battery will freeze easily.
- Check the electrolyte level weekly. Top off with distilled water as shown in figure 2. Do not overfill. Make sure that all plugs are tight.
- Make sure battery connections are tight and free from corrosion. A baking soda and water solution and a wire brush are helpful when cleaning battery connections. Keep caps on when cleaning batteries, so that electrolyte is not contaminated.

figure 2

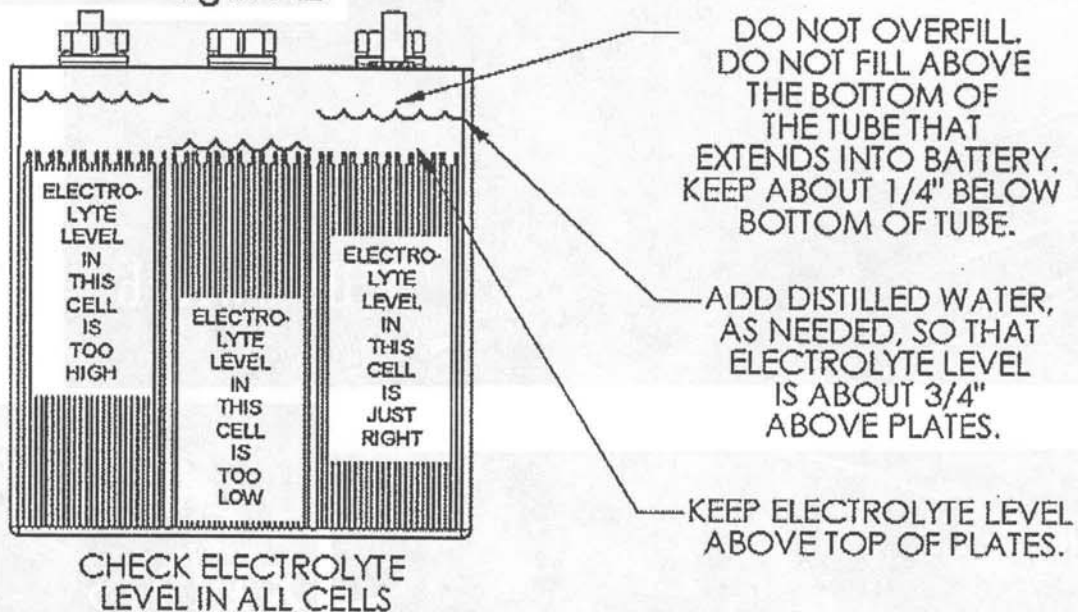

!!! BATTERIES ARE DANGEROUS !!!
READ THE SAFETY INSTRUCTIONS
IN THE FRONT OF THIS MANUAL
FOR SPECIFIC WARNINGS

IF YOU WOULD LIKE TO LEARN MORE ABOUT BATTERIES

THERE IS A VERY INFORMATIVE PUBLICATION AVAILABLE. IT COVERS SUBJECTS SUCH AS BATTERY TERMS AND HOW A BATTERY WORKS TO SPECIFIC GRAVITY TESTING WITH A HYDROMETER AND DIAGNOSIS OF BATTERY PROBLEMS.
YOU CAN OBTAIN A COPY OF THE "BATTERY SERVICE MANUAL" FROM

BATTERY COUNCIL INTERNATIONAL
401 N. MICHIGAN AVENUE
CHICAGO, IL 60611
PHONE 312-644-6610

Additional Information / views

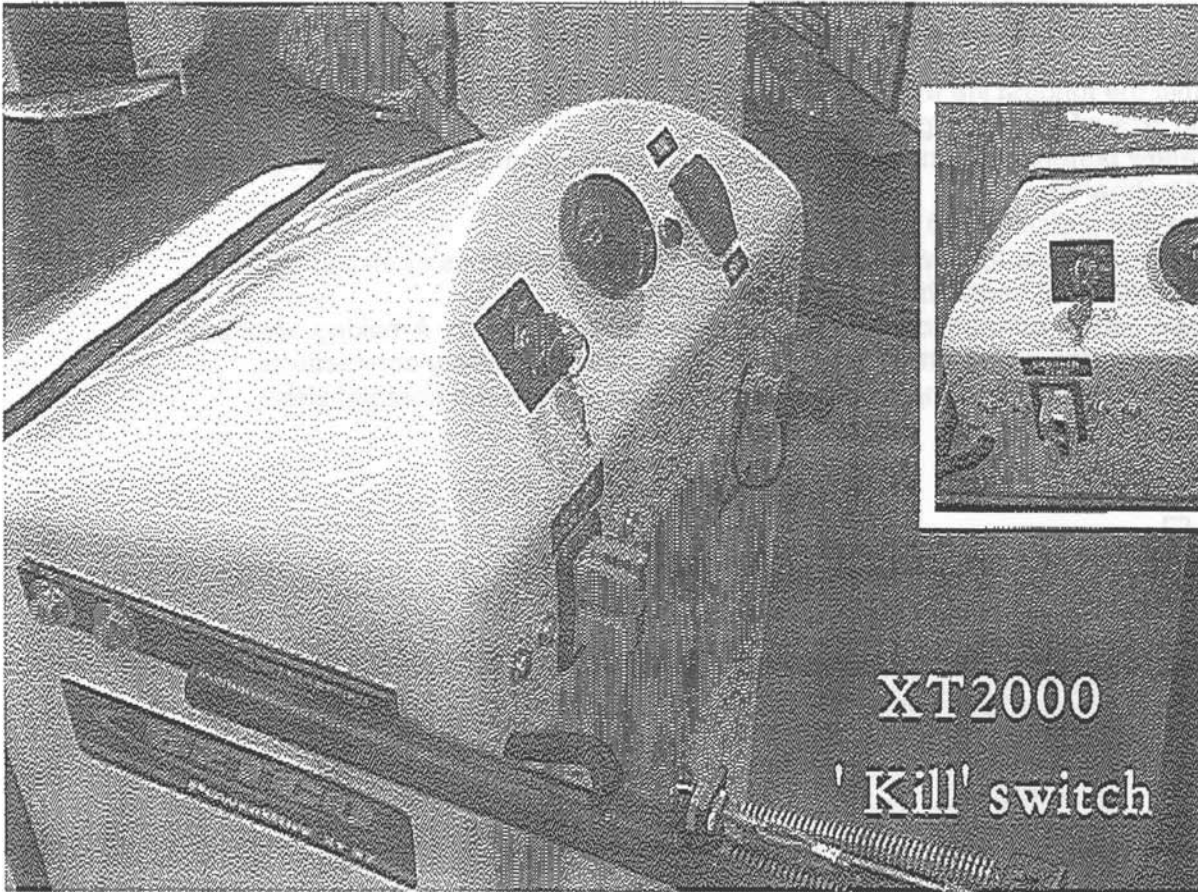

XT2000

' Kill' switch

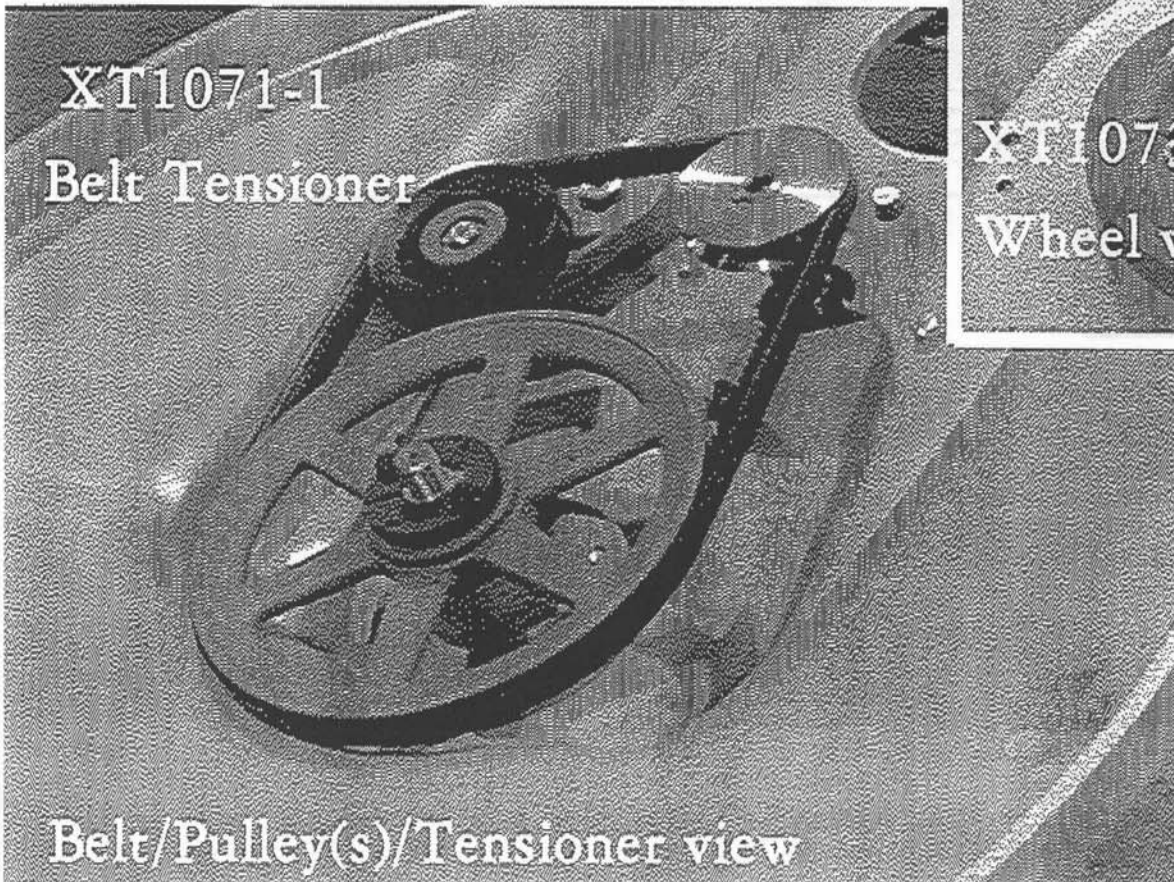
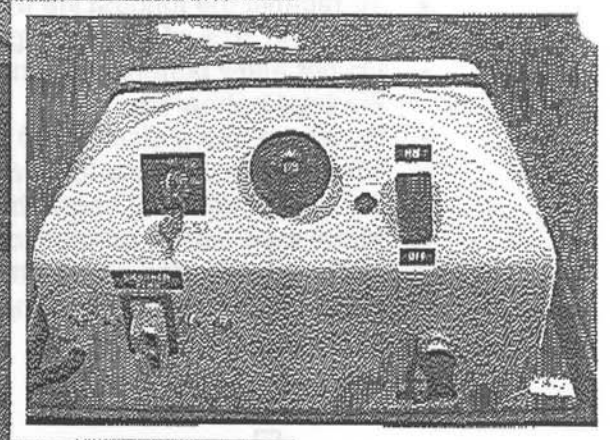

XT1071-1

Belt Tensioner

Belt/Pulley(s)/Tensioner view



XT1073

Wheel w/bushing

Generation 11

Drive Pulley & Flex-LOK

Assembly

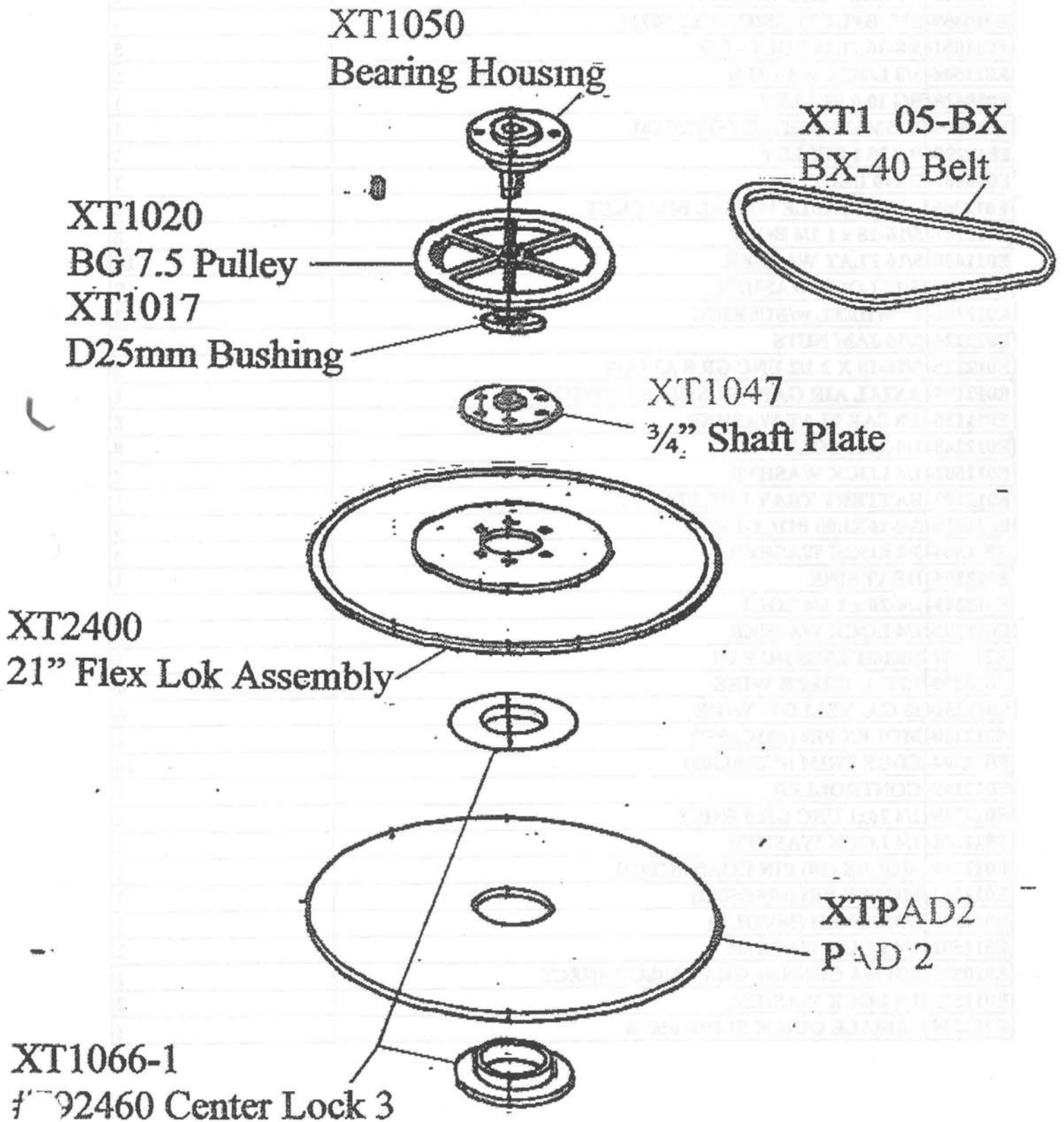

Part #	Description	Component Quantity
E011840	DURACOAT 28	1
E012217	7/16 ZINC LOCK WASHER	4
E012218	7/16 SAE G8 FLAT WASHER	4
E011132	1/2 SAE FLAT WASHER	1
E010459	SM. BELT TENSIONER/FS0111	1
E011051	3/8-16X1.25 BOLT - HH	5
E011504	3/8 LOCK WASHER	5
E010428	BG 10.0 PULLEY	1
E012400	D25MM BUSHING / QT25MM	1
E012295	BC 35 1 PULLEY	1
E010107	BX40 BELT	1
E012365	ADJUSTABLE WHEEL BRACKET	2
E012247	5/16-18 x 1 1/4 BOLT	8
E011498	5/16 FLAT WASHER	16
E011505	5/16 LOCK WASHER	8
E012181	6" WHEEL w/BUSHING	2
E012224	5/16 JAM NUTS	2
E012225	5/16-18 X 2 1/2 UNC GR 8 ALLOY	2
E012197	AXIAL AIR GAP BRUSHLESS MOTOR	1
E011136	3/8 SAE FLAT WASHER	8
E012248	1/4-20x1 BOLT	8
E011502	1/4 LOCK WASHER	8
E012192	BATTERY TRAY FOR 27"	1
E011050	3/8-16X1.00 BOLT-HH	4
E011504	3/8 LOCK WASHER	4
E012195	HEAT SINK	1
E012249	1/4-20 x 1 1/4 BOLT	2
E011502	1/4 LOCK WASHER	2
E012207	BRUSHLESS DC FAN	2
E012250	18 GA. GREEN WIRE	6
E012251	18 GA. YELLOW WIRE	6
E012210	MOLEX PIN (#35C5062)	2
E012204	EDGE TRIM (#75001309)	16
E012199	CONTROLLER	1
E012219	1/4 20x1 UNC GR 5 HHCS	4
E011502	1/4 LOCK WASHER	4
E012209	MOLEX (20) PIN CONNECTOR	1
E012210	MOLEX PIN (#35C5062)	7
E011230	SOLENOID (36VOLT)	1
E011502	1/4 LOCK WASHER	2
E010878	SB175A CONN.#4 GRAY DISCONNECT	1
E011502	1/4 LOCK WASHER	2
E012254	FEMALE QUICK SLIDE #5068	1

E012255	FEMALE QUICK SLIDE #5067	1
E011563	6 volt battery for AS2600, AS3	6
E012220	NYLON CABLE TIE, AF523	6
E012194	HANDLE	1
E011497	3/8 USS FLAT WASHER	6
E012243	3/8-16 SPINLOCK NUT	4
E012196	SAFETY SHUT-OFF HANDLE	1
E011642	SCRUBBER PALLET (36"x6')	1
E011641	SHIPPING BOX (SCRUBBER)	1
E012212	CHARGER PLUG LABEL	1
E012238	SMART WATERING SYSTEM LABEL	1
E012239	ON LABELS	1
E012240	OFF LABELS	1
E012206	27" MACHINE SHROUD (SET)	1
E012200	MILLENIUM 18-CELL SPW SYSTEM	1
E012201	REG.HOSE SYSTEM w/CONNECTOR	1
E011240	36 volt charger for AS3200, XT	1
E012189	REVERSE BUTTON	1
E010252	27" FLEX LOK ASSEMBLY	1
E012215	RED KILL SWITCH (#091130-02)	1
E011529	ROCKER SWITCH	1
E010865	36 VOLT SYSTEM GAUGE	1
E012237	3" CASTER w/GRAY RUBBER	2
E012235	REVERSE & REMOVE PAD DRIV. LAB	1
E012284	HOUSING COMPLETE / OLD STYLE	1
E011565	HANDLE RETURN SPRING	1
E012221	1/6 ALUM OVAL SLEEVE	1
E012260	RED RIGHT TERMINAL COVER	6
E012261	BLACK RIGHT TERMINAL COVER	6
E012214	300V MULTICONDUCTOR CABLE	6.33
E012236	CAP (BLACK) #CCF-1-10-14	2
E011886	PLASTIC POLY HINGE(1 1/2" BLK)	1
E011837	6 GA. x 7 LUG TO LUG	4
E011139	6 GA. x 15" "LUG TO LUG"	3
E011553	3/64 x 6" LANYARD 7 x 7 GAL AC	1
E012265	6 GA. RED x 28"-1/4 LUG BLACK	3
E012266	6 GA. x 14" LUG TO BRAKE	2
E010705	BUMPER GUARD (RED)	6
E012486	1/4 - 20 x 1" Stud, black plas	2
E010269	1/4-20 UNC ELASTIC LOCKNUT	2
E011317	1/4-20 x 3/4 UNC PAN HD PHIL	4
LOLABE	Labor Rate for Equipment	3.5
000OHE	OH Rate for Equipment	3.5
E011889	BRACKET FOR ANDERSON PLUG	2
E012512	RECTANGULAR GROMMET	1
E012513	POWER (RED) LIGHT	1

E012514	STAGIC STRIP (1"x 9")	1
E012517	CENTER LOK II (R) RH SET BLACK	1
E012290	KEY	1
E012291	SWITCH	1
E010353	27" AQUA BURNISHING PADS(5/CS)	1
E010550	LABEL,ON/OFF	1



Millennium™ Single Point Watering System
Operating Instructions

1. Fully open the water supply valve
2. Purge all air from the hose.
3. Join Quick Connector on water supply to battery coupling. Push together with a "snap."
4. The red balls in the Flow Indicator should begin to spin. When they stop spinning, the battery is full.
5. Disconnect immediately.

OPERATING INSTRUCTIONS

Flow-Rite Controls
3412 Louma Drive S.E.
Grand Rapids, MI 49548

P/N BL-008

Sept. 13, 2002

MILLENNIUM SPW™

IMPORTANT

DO NOT USE WITH

Snap-Fill™ or POWERSTREAM™

P/N BD-LBL-016

PURGING INSTRUCTIONS

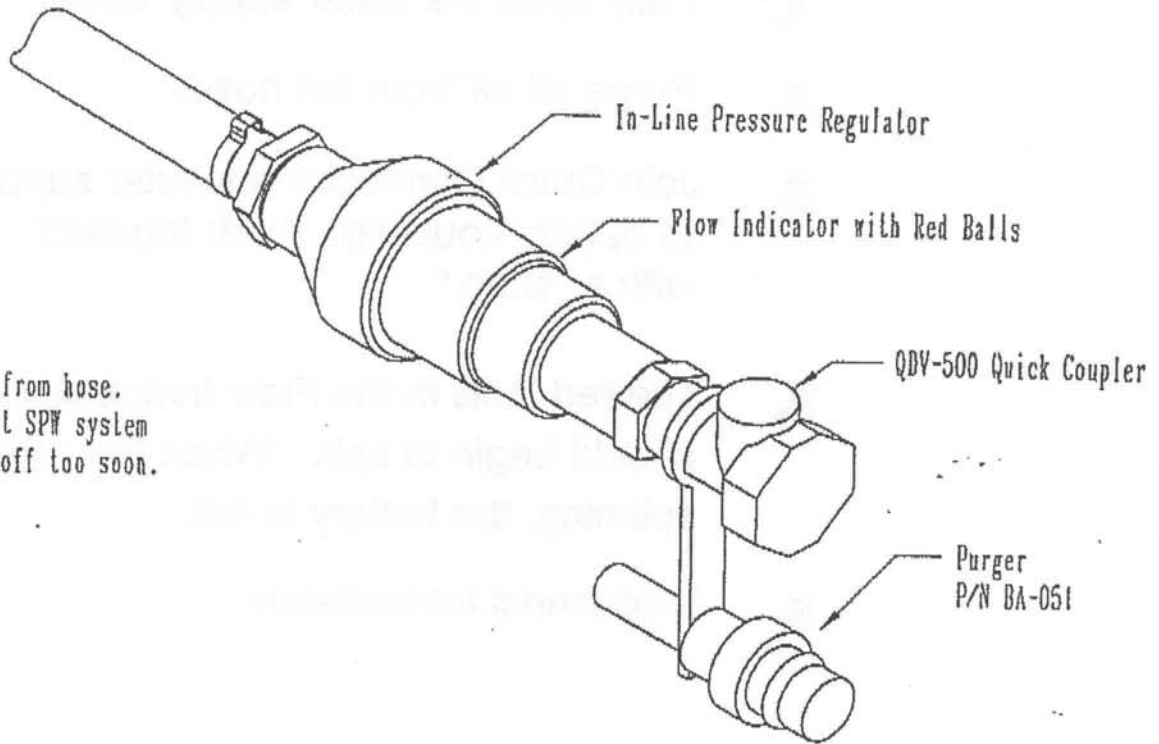

Purge to remove air from hose.
Purpose is to prevent SPW system
valves from turning off too soon.

Air is purged out when water flow is steady and solid.

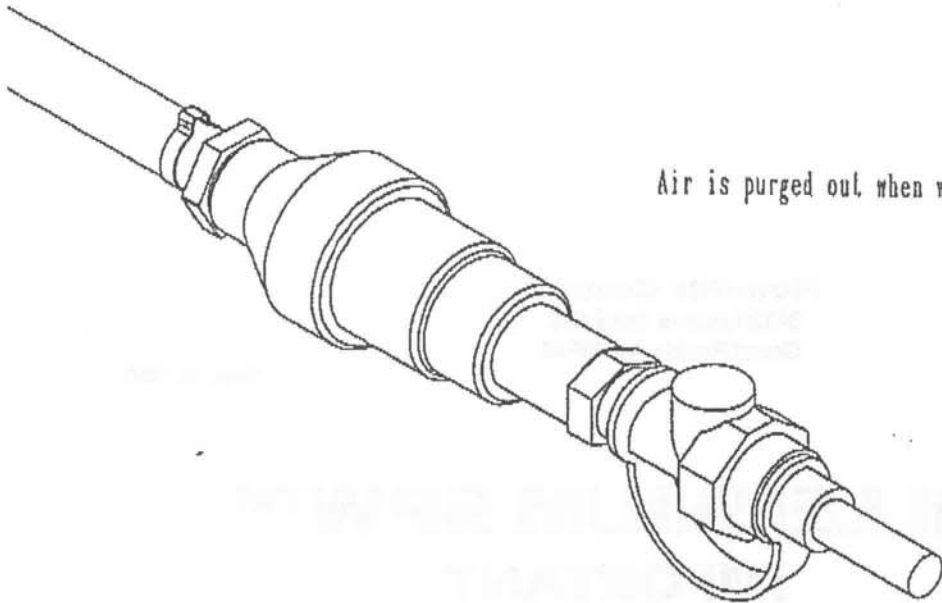

Aim towards drain or bucket.

MILLENNIUM HOSE SYSTEM INSTALLATION & OPERATING INSTRUCTIONS

Refill batteries after they have been charged.
One watering per week is usually enough.

Connect to a hose bibb. —

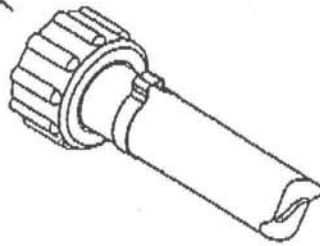

Red balls in Flow Indicator will spin when
water is flowing. When balls stop, push
CPC button in and disconnect couplers.

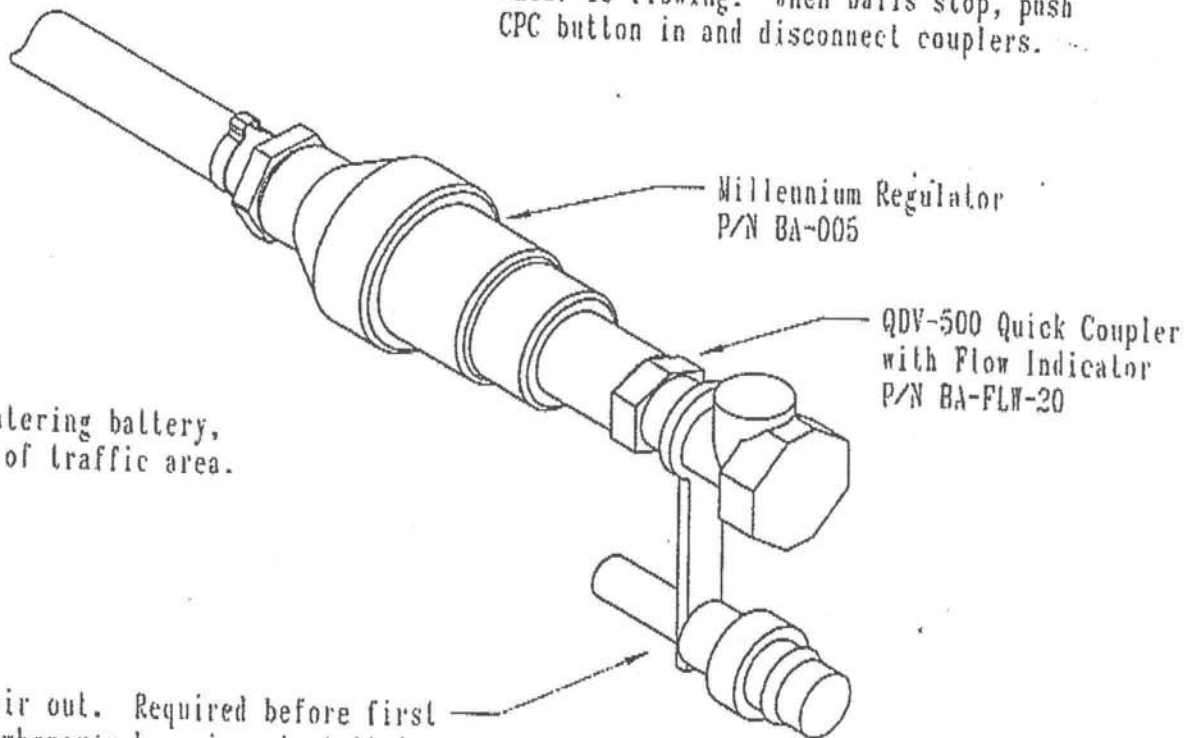

When through watering battery,
store hose out of traffic area.

Purge air out. Required before first
use or whenever hose is reinstalled.
Purger P/N BA-051

MILLENNIUM HOSE SYSTEM INSTALLATION & OPERATING INSTRUCTIONS

Connect to a hose bibb.

Refill battery after they have been charged.
One watering/filling per week is usually enough

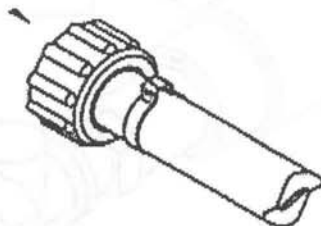

Red balls in Flow Indicator will spin when water is flowing. When balls stop, push CPC button in and disconnect couplers.

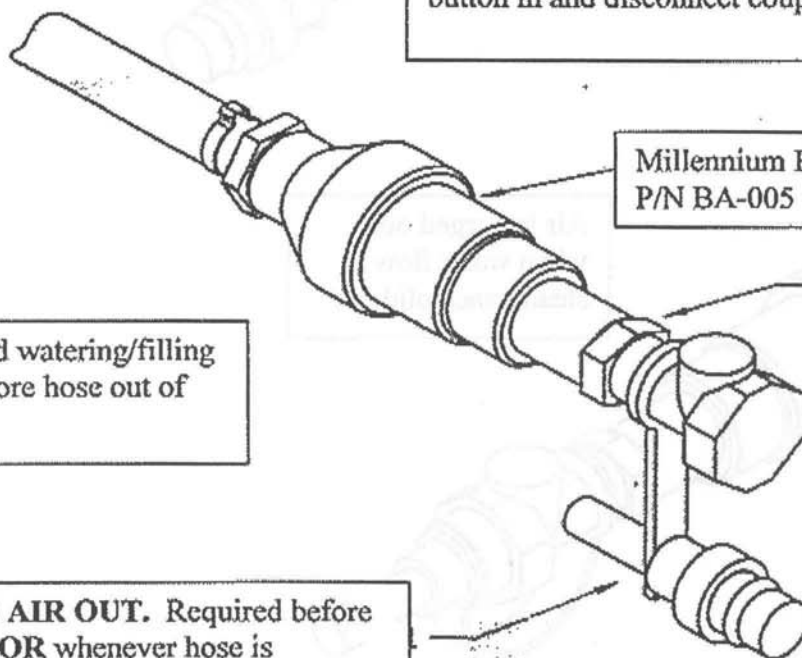

Millennium Regulator
P/N BA-005

QDV-500 Quick Coupler
with Flow Indicator P/N
BA-FLW-20

When finished watering/filling
the battery, store hose out of
traffic area.

PURGE AIR OUT. Required before
first use **OR** whenever hose is
reinstalled. Purger P/N BA-051

PURGING INSTRUCTIONS

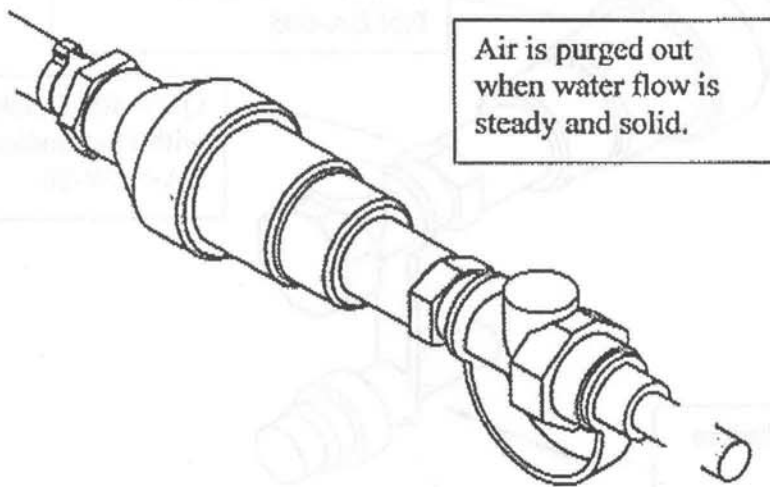
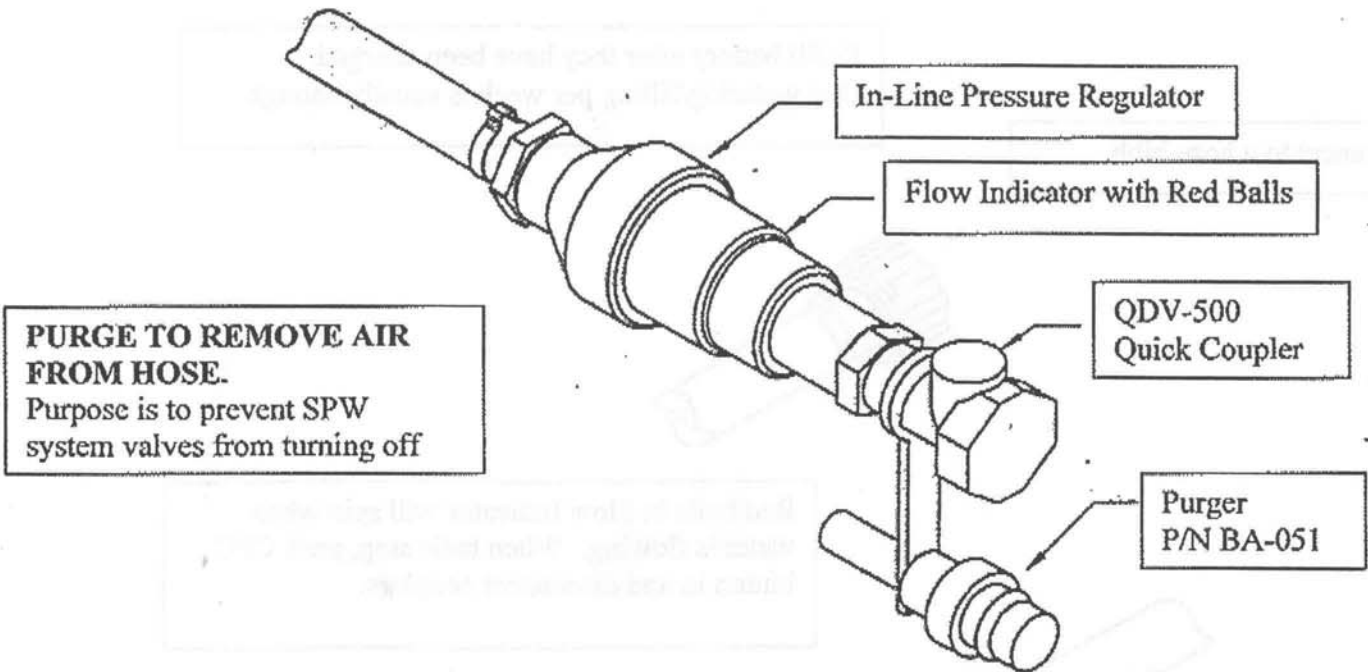

XT GEN 2 WIRING DIAGRAM (NEW CONFIGURATION)

UPDATED BY STEVE YOUNTS 4/17/07

