

# BAC PAC II

Chemicals  
Equipment  
Programs  
Process



## 10 Quart Bac Pac Vacuum

The Bac Pac II provides a high productivity alternative to upright vacuum cleaning reducing labor substantially. Versatile, this unit allows total floor to ceiling cleaning making it ideal for all types of dry vacuuming applications. The Bac Pac II includes a standard tool kit and features an ergonomically designed backrest to enhance operator comfort.

### Applications

- Residential/Commercial carpets and hard floors
- Office partitions/Cubicles
- Blinds/Draperies/Vents/Ducts

### Features

- Tapered body design allows consistent airflow around the filter bag
- Sound deadening baffle foam reduces noise level
- Static dissipating vacuum hose
- Bag deflector plate keeps particles from tearing filter bag
- Bag support plate over motor keeps heavy bags from impeding airflow
- Swivel cuff vacuum hose
- Standard tool kit included



**Standard Tool Kit Contents**  
14" floor tool, 4" upholstery tool, 3" dusting brush, 11" crevice tool, and 2-piece 2-bend aluminum wand.



**Ergonomic backrest and onboard tool holder.**

### Warranty

Tank: 10 years  
Other Components: 3 year\*

\*Please refer to Betco Equipment Price/Product Guide for complete equipment warranty information.

Authorized Betco Distributor

### Specifications

Tank size .....	10 quart
Vacuum motor .....	1.6 hp (1-Stage bypass)
Noise level .....	67 dB
Filtration .....	Paper or micro filter bags
Water lift .....	100"
Airflow .....	150 cfm
Power cord .....	50'
Volts .....	115 volts
Amps .....	11.5 amps
Vacuum hose ..	Angled w/swivel cuff, affixed to lid assembly
Height .....	23"
Weight .....	10 lbs.
Tool kit .....	Included
Productivity - floor surface .....	7,500 sq. ft./hour
Productivity - stairways/landings .....	2,900 sq. ft./hour
Productivity - office partitions .....	2,200 sq. ft./hour

### Available In

Bac Pac II: Item #85902-00

Literature Item #85902-92

<b>FILTRATION</b>		
<b>PAPER FILT</b>		<b>% Removed</b>
Particulate Si		
0.3		79%
0.5		80%
1.0		90%
<b>PAPER FILT</b>	<b>MICRO FILTER</b>	<b>% Removed</b>
Particulate Si		
0.3		98.50%
0.5		99.20%
1.0		99.70%

01.04



**Save These  
Instructions**

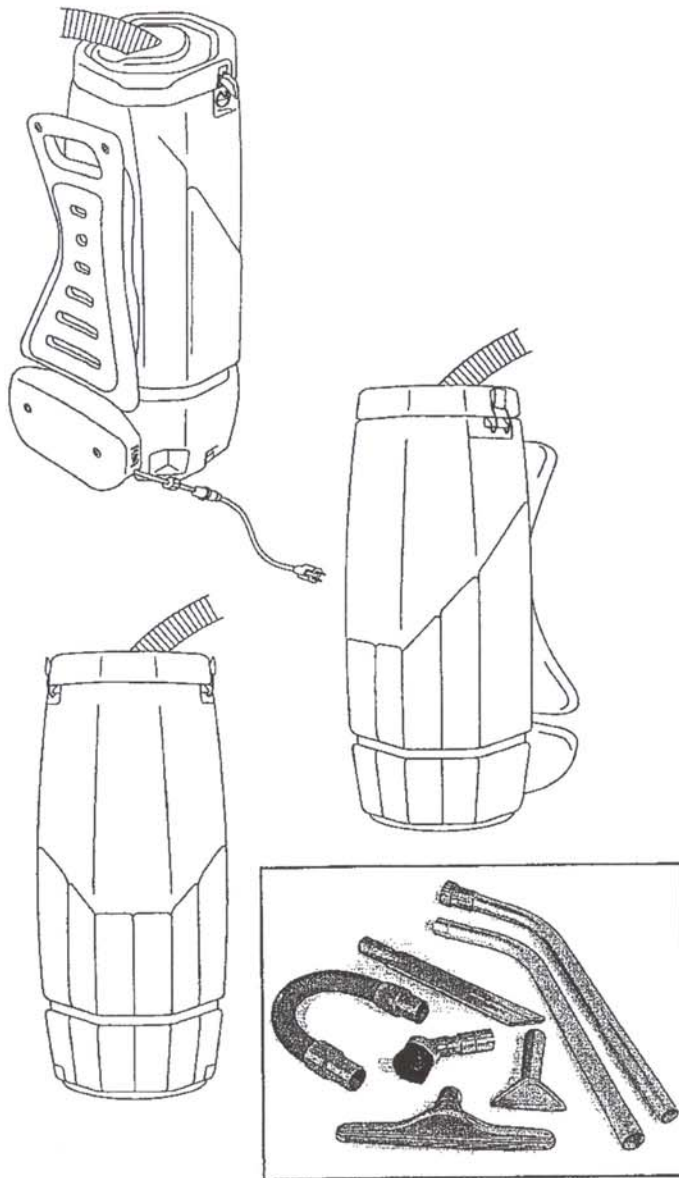

**Read and Follow All  
Instructions,  
Warnings and Cautions  
Before Using This  
Vacuum.**

**Safety,  
Operation  
And  
Maintenance  
Manual  
w/Parts List**

**Backpack  
Vacuum**

*This unit is intended for commercial use.*

# IMPORTANT SAFETY INSTRUCTIONS

## PLEASE READ CAREFULLY BEFORE OPERATING

This vacuum will afford you many years of trouble-free operating satisfaction, provided it is given proper care. All parts have passed rigid quality control standards prior to their being assembled to produce the finished product. Prior to packaging, your vacuum was again inspected for assurance of flawless assembly.

This vacuum is protectively packed to prevent damage in shipment. We recommend that upon delivery, unpack the unit and inspect it for any possible damage. Only a visual examination will reveal damage that may have occurred.

If damage is discovered, immediately notify the transportation

company that delivered your vacuum. As a shipper, we are unable to report any claim for damage. You must originate any claim within 5 days.

This manual is for your protection and information. PLEASE READ CAREFULLY since failure to follow precautions could result in discomfort or injury.

## IMPORTANT SAFETY INSTRUCTIONS

### WARNING:

**To Reduce the Risk of Fire, Electric Shock or Injury:  
Electric shock could occur if used on wet surfaces.  
DO NOT expose to rain. Store indoors.**

*When using this vacuum basic precautions should always be followed, including the following:*

1. **DO NOT** leave the vacuum when plugged in. Unplug from the outlet when not in use and before servicing.
2. To avoid electric shock, **DO NOT** expose to rain. Store indoors. **DO NOT** use on wet surfaces.
3. This is **NOT** a toy. Close attention is necessary when used around or near children.
4. Use only as described in this safety manual. Use only manufacturer's recommended attachments and accessories.
5. **DO NOT** use this vacuum with damaged cord or plug. If the vacuum is not working as it should, because it has been dropped, damaged, left outdoors or dropped into water, contact an authorized service center or factory.
6. **DO NOT** pull or carry by the cord, use cord as a handle, close a door on cord or pull cord around sharp edges and corners. Keep cord away from heated surfaces.
7. **DO NOT** unplug the vacuum by pulling on the cord. To unplug, grasp the plug, not the cord.
8. **DO NOT** handle the plug of the vacuum with wet hands.
9. **DO NOT** put any objects into openings. **DO NOT** use with any opening blocked; keep free of dust, lint, hair and anything that may reduce air flow.
10. Keep hair, loose clothing, fingers, and all parts of body away from openings and moving parts.
11. **DO NOT** pick up anything that is burning or smoking, such as cigarettes, matches, or hot ashes.
12. **DO NOT** use without dust bag and/or filters in place.
13. **DO NOT** use the vacuum to pick up flammable or combustible liquids such as gasoline or use in areas where they may be present.
14. Use extra care when cleaning on stairs.
15. **DO NOT** use where oxygen or anesthetics are used.
16. Turn off all controls before unplugging.
17. The extension cord is provided with this unit is 50 foot, #16, 3 wire and **MUST** be used with this unit to insure grounding protection.
18. Replace damaged or worn parts immediately with genuine original equipment parts to maintain safety and to protect your limited warranty.

This vacuum has a outlet for a motorized power nozzle, always turn OFF vacuum before connecting or disconnecting the motorized nozzle. This vacuum must be connected to a properly grounded outlet only. (See grounded instructions)

# SAVE THESE INSTRUCTIONS

# Grounding Instructions

## GROUNDING INSTRUCTIONS

### DANGER:

Improper use of the grounding plug can result in a risk of electric shock.

Electrical equipment must be grounded. If it should mal-function or breakdown, grounding provides a path of least resistance for electrical current to reduce the risk of electric shock. The vacuum is equipped with a cord having an equipment-grounding conductor and grounding plug. The plug must be inserted into an appropriate outlet that is properly installed and grounded in accordance with all local codes and ordinances.

If repair or replacement of the cord or plug is necessary, DO NOT connect the grounded wire to either flat blade terminal. The wire with insulation having an outer surface that is green with or without yellow stripes is the grounding wire.

## GROUNDING METHODS

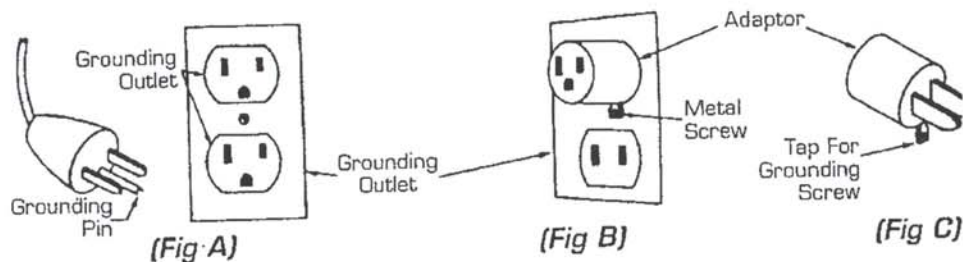

This electric equipment is for use on a nominal 120 volt circuit, and has a grounded plug that looks like the plug illustrated in (Fig A). A temporary adaptor that looks like the adaptor illustrated in (Fig B & C) may be used to connect this plug to a 2-pole receptacle as shown in (Fig B) if a properly grounded outlet is not available.

The temporary adaptor should be used only until a properly grounded outlet (Fig A) can be installed by a qualified electrician. The green color rigid ear, lug or the like extending from the adaptor must be connected to a permanent ground such as a properly grounded outlet box cover. Whenever the adaptor is used, it must be held in place by a metal screw.

### WARNING:

Improper connection of the equipment-grounding conductor can result in a risk of electric shock. Check with a qualified electrician or service person if you are in doubt as to whether the outlet is properly grounded. DO NOT modify the plug provided with the equipment. If it will not fit the outlet, have a proper outlet installed by a qualified electrician.

Note: In Canada, the use of a temporary adaptor is not permitted by the Canadian Electrical Code.

## CARE OF YOUR VACUUM CLEANER

Treat your vacuum cleaner as you would any other high grade precision made product. Dropping, unreasonable bumping across thresholds and other misuses may result in a damaged unit which will not be covered by warranty.

When not in use the power cord should be wrapped around the molded-in cord wrap for storage. After each use, wipe the vacuum body, accessories and power cord with a damp cloth.

Read this manual completely before operating this vacuum. It is important to follow the instructions in the manual to prevent the possibility of injury or damage to the user and/or machine.

# Importantes Mesures De Sécurité

## LIRE TOUTES LES INSTRUCTIONS AVANT DE FAIRE FONCTIONNER (CET APPAREIL)

### AVERTISSEMENT:

Pour réduire les risques d'incendie, de choc électrique ou de blessure:  
L'utilisation d'un appareil électrique demande certaines précautions:

1. Ne pas laisser l'appareil sans surveillance lorsqu'il est branché. Débrancher lorsque l'appareil n'est pas utilisé et avant l'entretien.

2. Ne pas permettre aux enfants de jouer avec l'appareil. Une attention particulière est nécessaire lorsque l'appareil est utilisé par des enfants ou à proximité de ces derniers.

3. N'utiliser que conformément à cette notice avec les accessoires recommandés par le fabricant.

4. Ne pas utiliser si le cordon ou la fiche est endommagé. Retourner l'appareil à un atelier de réparation s'il ne fonctionne pas bien, s'il est tombé ou s'il a été endommagé, oublié à l'extérieur ou immergé.

5. Ne pas tirer, soulever ou traîner l'appareil par le cordon. Ne pas utiliser le cordon comme une poignée, le coincer dans l'embrasure d'une porte ou l'appuyer contre des arêtes vives ou des coins. Ne pas faire rouler l'appareil sur le cordon. Garder le cordon à l'écart des surfaces chaudes.

6. Ne pas débrancher en tirant sur le cordon. Tirer plutôt la fiche.

7. Ne pas toucher la fiche ou l'appareil lorsque vos mains sont humides.

8. N'insérer aucun objet dans les ouvertures. Ne pas utiliser l'appareil lorsqu'une ouverture est bloquée. S'assurer que de la poussière, de la peluche, des cheveux ou d'autres matières ne réduisent pas le débit d'air.

9. Maintenir les cheveux, les vêtements amples, les doigts et toutes les parties du corps à l'écart des ouvertures et des pièces mobiles.

10. Ne pas aspirer de matières en combustion ou qui dégagent de la fumée, comme des cigarettes, des allumettes ou des cendres chaudes.

11. Ne pas utiliser l'appareil si le sac à poussière ou le filtre n'est pas en place.

12. Mettre toutes les commandes à la position ARRÊT avant de débrancher l'appareil.

13. User de prudence lors du nettoyage des escaliers.

14. Ne pas aspirer des liquides inflammables ou combustibles, comme de l'essence, et ne pas faire fonctionner dans des endroits où peuvent se trouver de tels liquides.

15. Toujours mettre l'interrupteur de l'appareil à la position ARRÊT avant de brancher ou de débrancher la brosse à moteur.

16. Ne brancher qu'à une prise de courant avec mise à la terre. Voir les instructions visant la mise à la terre.

## INSTRUCTIONS VISANT LA MISE A LA TERRE

Cet appareil doit être mis à la terre. En cas de défaillance ou de panne éventuelles, la mise à la terre fournit au courant un chemin de moindre résistance qui réduit le risque de choc électrique. Cet appareil est pourvu d'un cordon muni d'un conducteur de terre et

d'une fiche avec broche de terre. La fiche doit être branchée dans une prise appropriée correctement installée et mise à la terre conformément aux règlements et ordonnances municipaux.

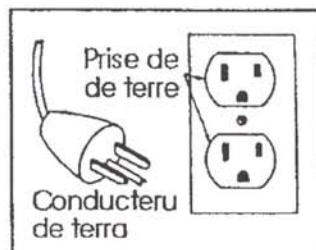

Cet appareil est destiné à un circuit de 120V et est muni d'une fiche de mise à la terre semblable à celle illustrée par le croquis A de la figure "A". S'assurer que l'appareil est branché à une prise

de courant ayant la même configuration que la fiche. Aucun adaptateur ne devrait être utilisé avec cet appareil.

### AVERTISSEMENT

Un conducteur de terre mal raccordé peut entraîner un risque de choc électrique. Consulter un électricien ou un technicien d'entretien qualifié si vous n'êtes pas certain que la prise soit correctement mise à la terre. Ne pas modifier la fiche

fournie avec l'appareil-si elle ne peut être insérée dans la prise, faire installer une prise adéquate par un électricien qualifié.

# CONSERVER CES INSTRUCTIONS

# Operation & Assembly Instructions

## PREPARATION AND OPERATION - DRY ONLY

This vacuum is equipped with a air-thru motor and is designed for dry pickup only. Unpack the carton and remove the vacuum and attachments. The backpack comes assembled you will need to install the hose and attachment.

### To Change Paper Filter Bag

- 1) Turn top cap of vacuum a half counterclockwise and lift off the body.
- 2) Remove full paper bag from the tank and dispose of properly.
- 2) Expand paper filter bag and set inside the cloth filter.
- 3) Reinstall top cap and turn a half clockwise to tighten.

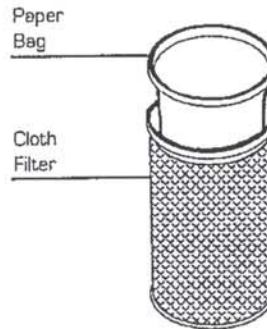

### Cloth Filter Maintenance

The cloth filter should be cleaned each time you empty the tank. **DO NOT WASH** the cloth filter because shrinkage of the cloth and damage to the gasket can occur. To clean the cloth filter, shake off loose particles and brush exposed surface with a soft bristle brush.

### CAUTION:

Always exercise caution when handling the vacuum. Dropping the vacuum could cause permanent damage to the internal components.

## ASSEMBLY OF ATTACHMENTS

### To Connect Hose

- 1) Connect one end of the hose into the inlet on top of vacuum.
- 2) Connect the other end of hose to the wand or tool you are planning to use.

### Wand Assembly

The two piece wand requires some assembly.

- 1) Align the button lock of the upper wand section with the opening for button lock in the lower wand section.
- 2) Push sections together, unit lock is accomplished.



### To Assemble Tools

- 1) Turn wand nut counterclockwise approximately four complete turns.

- 2) Insert the tool into wand and coupling.

- 3) While holding tool in place, turn nut clockwise until wand nut is fully locked.

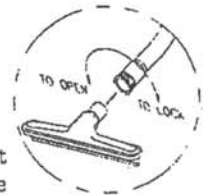

# Schematic Drawing

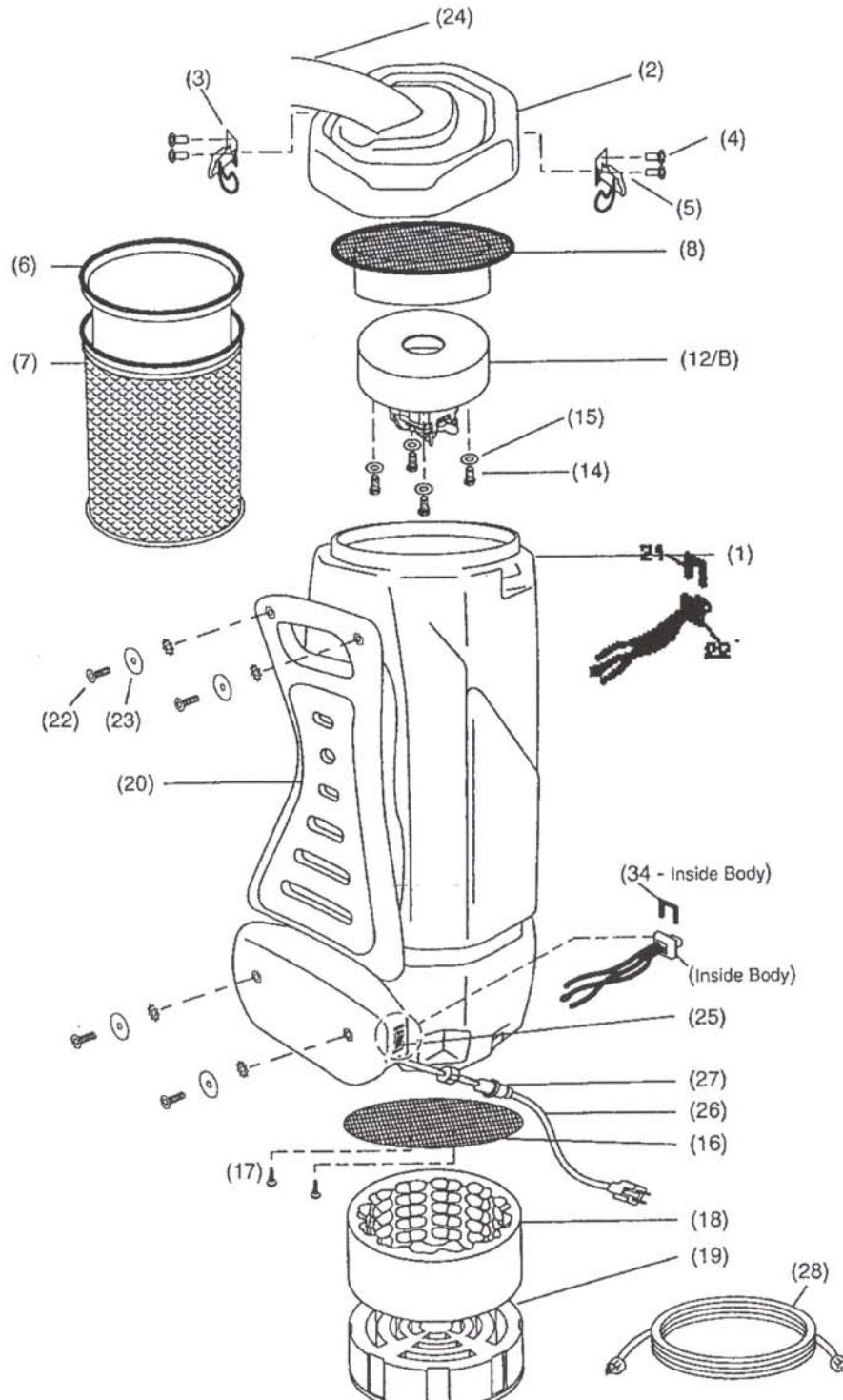

# Replacement Parts List

## Parts Breakdown

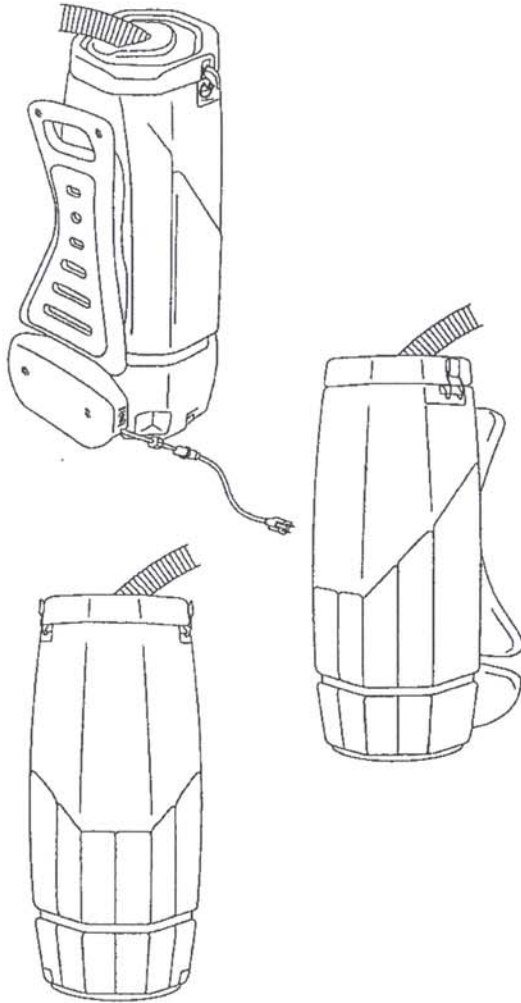

10-0001	Body
10-0002	Lid
10-0003	Lid Latch
10-0004	Lid Rivet
10-0005	Lid Rivet/Washer
10-0006	Micro-Lined Paper Bag
10-0007	10-qt Cloth Bag & Gasket
10-0008	Dome Filter
10-0009	Dome Filter Rivet
10-0010	Dome Filter Deflector Plate
10-0011	Dome Filter Deflector Plate with Trim/Lock
10-0012	Motor XP-Whisper
10-0013	Motor Super/Raven
10-0014	Motor Screws
10-0015	Motor Washers
10-0016	Motor Deflector
10-0017	Motor Deflector/Screws
10-0018	Sound Filter/Band
10-0019	Dual Cell Noise Filter
10-0020	Cushion Back Pad
10-0021	Shoulder & Waist Belt (not shown)
10-0022	Shoulder & Waist Belt Screws
10-0023	Shoulder & Waist Belt Washers
10-0024	Vacuum Hose - Smooth Core
10-0025	On/Off Switch
10-0026	17" Power Cord
10-0027	Pigtail & Nut
10-0028	50' Electric Cord



# ***Trouble Shooting Guide***

## **CAUTION**

**Always disconnect power cord before servicing vacuum**

## **WARNING**

**Repairs should only be performed by an authorized service center.**

### **PROBLEM: Loss of Vacuum.**

---

#### **CAUSE:**

1. Cap is damaged.
2. Faulty vacuum motor.
3. Full paper filter bag.
4. Clogged hose or wand.
5. Loose or broken fan.

#### **SOLUTION:**

1. Inspect and replace if needed.
2. Call manufacturer or service center.
3. Replace paper filter bag.
4. Remove obstruction.
5. Contact manufacturer or service center.

### **PROBLEM: Motor is not running.**

---

#### **CAUSE:**

1. Faulty ON/OFF switch.
2. Power cord defective.
3. Loose connection or wiring.
3. Motor defective.
4. Blown fuse or tripped circuit breaker.

#### **SOLUTION:**

1. Contact manufacturer or service center.
2. Contact manufacturer or service center.
3. Contact manufacturer or service center.
4. Contact manufacturer or service center.
5. Replace fuse or reset circuit breaker.

### **PROBLEM: Dust blowing from vacuum when running.**

---

#### **CAUSE:**

1. Full paper filter bag.
2. Paper filter bag not installed properly.
3. Cloth filter bag dirty.
4. Cloth or paper filter bag is torn.

#### **SOLUTION:**

1. Replace filter bag.
2. Reinstall or replace paper filter bag properly.
3. Clean cloth filter bag.
4. Replace.