

Foreman™ 21 Propane Burnisher

Parts Schematic

Item #87055

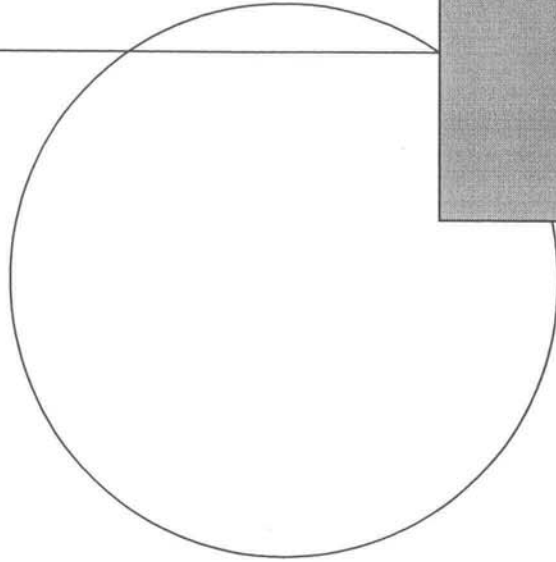

87055 Foreman 21 Propane Burnisher Parts Schematic

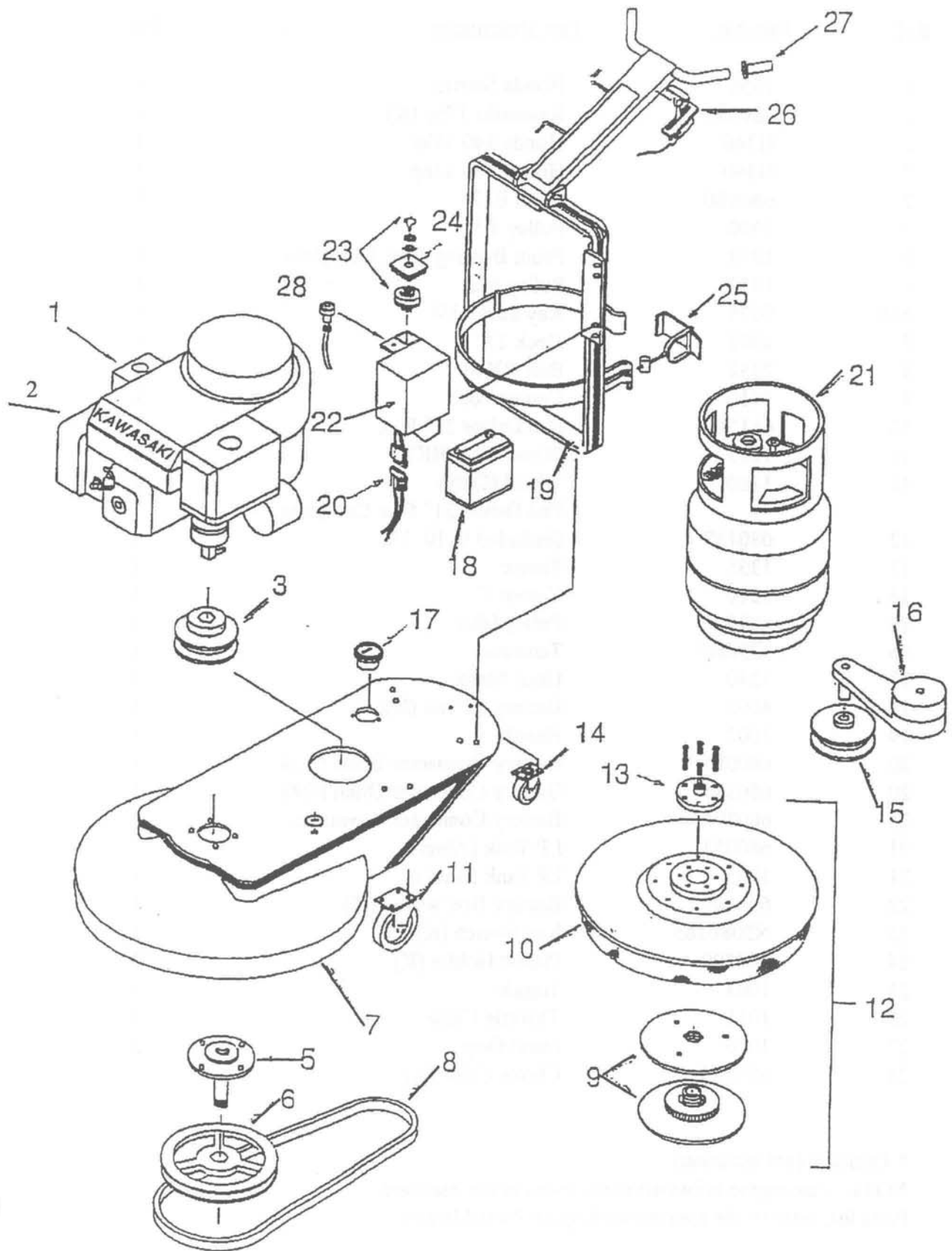

87055 Foreman 21 Propane Burnisher Parts Schematic

<u>Ref.</u>	<u>Part No.</u>	<u>Part Description</u>	<u>Qty.</u>
1	1550	Honda Starter	1
2	680187	Kawasaki 17hp (K)	1
2	H340	Honda 340 11hp	1
2	H390	Honda 390 13hp	1
2	680080	Onan E124	1
3	1300	Pulley 3.5	1
5	1373	Front Bearing Assy. Complete	1
6	1310	Pulley 6.2	1
N/S	9075	Key Stock 1/4	1
7	1001	Deck 21"	1
8	2332	Belt BX40	1
9	1410	Center Lock	1
10	68177	Pad Driver 21" Flex	1
11	1205	Wheel 6" w/BKT	2
11	1200	Wheel (Only)	2
12	680157	Pad Driver 21" Flex Complete (included 9, 10, 13)	1
13	1355	Flange	1
14	1210	Caster 3"	1
15	1235	Pulley Idler	1
16	1230EF	Tensioner	1
17	1240	Hour Meter	1
18	4002	Battery 12 volt (K)	1
19	1002	Handle	1
20	680096	Battery Connector Onan E124	1
20	680215	Battery Connector Onan P248	1
20	680296	Battery Connector Kawasaki	1
21	680053	LP Tank (Alum)	1
21	1705	LP Tank (Steel)	1
22	680198	Battery Box w/Key (K)	1
23	N3080385	Key Switch (K)	1
24	680209	Plastic Holder (K)	1
25	1003	Toggle	1
26	1015	Throttle Cable	1
27	1010	Hand Grip	2
28	680255	Choke Cable (K)	1

*-Optional (not included)

NOTE: For engine information not listed in the Standard Parts list, refer to the appropriate Engine Parts Manual.

Propane Burnisher

Operator's Manual

Item #87055

#87049

#87053

#87052

#87054

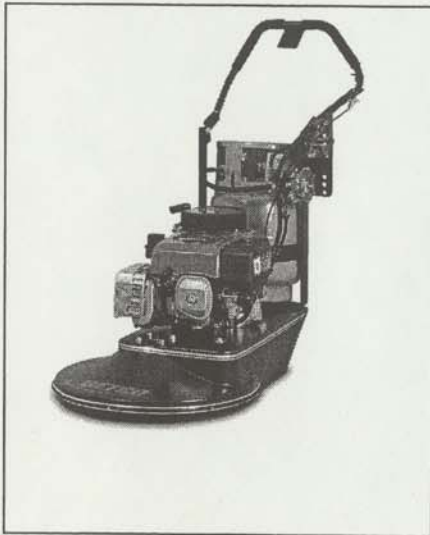

OPERATION

PRECAUTIONARY INSTRUCTIONS

 This symbol is used throughout this manual to warn of hazards or unsafe practices which could result in personal injury to yourself or others.

 **ATTENTION!** Please read and follow all the instructions in this manual as well as the "*Safety Awareness Manual*" included in the documentation shipped with this machine before operating the machine.

1. Check fuel cylinder for overfill before taking it into the building or placing it in storage.
2. Install fuel cylinder in a well ventilated place.
2. Be aware of possible leaks of propane gas if odor is present.
3. Check carburetor air filter for cleanness before starting engine.
4. Never run the engine with the throttle in the choke position.
5. Never leave the machine unattended while the engine is running.
5. If the machine is stored inside the building, remove the fuel cylinder & store properly outside.
7. Secure cylinders when being transported. If attached to the machine service valves should be OFF.
8. Never store fuel cylinders in your van where they me be exposed to high temperature.
9. Maintain the propane powered floor machine as directed by the manufacturer.
10. Only trained operators should be allowed to operate propane powered floor machines.

Copyright © 2001 Eagle Solutions LLC.

All rights reserved.

Reproduction or translation of any part of this work is beyond that permitted by section 107 or 108 of the 1976 Unites States Copyright Act without the permission of the copyright owner is unlawful. Requests for permission or further information should be addressed to the Permission Department, *Eagle Solutions LLC*. PO Box 443 Adairsville GA. 30103

This publication is designed to provide accurate and authoritative information in regard to the subject matter covered. It is provided with the understanding that the publisher is not engaged in rendering legal or other professional services.

This manual is furnished with each new propane powered floor machine. It provides necessary operation and maintenance instructions. **Read and understand the information in this manual before operating or servicing this machine!**

Additional copies may be ordered through Customer Service.

When ordering replacement parts use the standard Parts list in this manual. Before ordering parts or supplies, be sure to have your machine model number and serial number handy. Parts and supplies may be ordered by phone, Fax, or mail from any Authorized Service Center or Distributor.

You have purchased one of the finest floor machines engineered and manufactured. It will provide excellent service for years to come. However the best results will be obtained if:

1. The machine is operated with reasonable care.
2. The machine is maintained regularly as suggested by the manufacturer.

MACHINE DATA

Please fill out for future reference.

Model No. _____

Date of purchase _____

Serial No. _____

NOTE: Specification are subject to change without notice.

TABLE OF CONTENTS

PRECAUTIONARY INSTRUCTIONS.....	2	LIFE OF MACHINE.....	10
SAFETY PRECAUTIONS.....	4	FUEL SYSTEM.....	10
MACHINE SETUP.....	5	CHANGING OIL.....	10
OIL LEVEL & FILTERS.....	5	ADJUSTING BELT TENSION.....	10
HANDLE ADJUSTMENT.....	5	FILLING AND STORING CYLINDERS.....	11
INSTALLING FUEL CYLINDER.....	5	FILLING.....	11
INSTALLING PAD DRIVER & PADS.....	5	STORING.....	11
MACHINE OPERATION.....	6	STORING MACHINE.....	11
STARTING ENGINE.....	6	TRANSPORTING MACHINE.....	11
OPERATING THE CLUTCH.....	6	TROUBLE SHOOTING GUIDE.....	12
OPERATION OF TRACKER 3000.....	6	STANDARD PARTS.....	13
OPERATION OF DUST CONTROL.....	7		
OPERATION OF EASY GLOSS SPRAY.....	7		
STOPPING THE ENGINE.....	7		
EMERGENCY STOPPING.....	7		
CONVERTING THE PRIDE 2100 (STRIP/BUFF).....	8		
MAINTENANCE.....	9		
DAILY.....	9		
WEEKLY.....	9		
MONTHLY.....	9		
QUARTERLY.....	9		

OPERATION

SAFETY PRECAUTIONS

1. This propane fueled machine is intended for commercial use only. It is designed to clean floors. Do not use the machine other than described in this Operator Manual.

2. All operators must read, understand & practice following the safety precautions in this section as well as the "Safety Awareness Manual" included in the literature packet.

3. Only trained authorized operators should operate propane powered floor machines.

4  Check fuel cylinders for overfill before taking them into the building or your van. (See page 11 for instructions).

BEFORE OPERATING THE MACHINE:

- Check oil level
- Check air filter
- Check pad & pad holder
- Adjust handle height
- Install fuel cylinder in a well ventilated area.

WHILE OPERATING THE MACHINE:

 Even though the 89 db sound level is below OSHA's PEL it is the course of wisdom to wear hearing protection while operating any internal combustion engine.

 If you smell propane gas stop the engine, remove the cylinder and take it outside for inspection.

 Be aware of odors other than propane. Toxic emissions are produced by internal combustion engines. Properly maintained engines produce a small amount of these gasses. Although Carbon Monoxide has no odor, the hydrocarbons do, and an elevation of the odor may indicate increased CO as well.

Do not allow the machine to run unattended except for short times while moving an obstruction.

 Exhaust parts are extremely HOT, be careful not to allow them to come in contact with anything or anyone.

Do not attempt to change pads while engine is running.

BEFORE LEAVING THE MACHINE:

Stop the engine by closing the service valve on the fuel cylinder.

Remove the key from the switch if applicable.

Remove the cylinder from the machine and store outside in a secure cabinet. (See page 12)

Inspect and clean air and dust filters.

SERVICING THE MACHINE:

Preventive maintenance is the responsibility of the operator. It includes:

1. Checking oil level
2. Checking and cleaning air & dust filters
3. Keeping the machine clean and lubricated
4. Reporting any damage or worn parts.
5. See page 9 for service intervals & instructions.

 Servicing or adjusting the propane fuel system can only be done by a trained service technician!

 **Never attempt to adjust the fuel system of a propane engine! If equipped with an emission monitoring or control system never attempt to disconnect it or circumvent it!**

MACHINE SETUP

CHECKING OIL LEVEL & FILTERS:

Check oil level prior to starting engine. Use specified oil if necessary to add. **DO NOT OVER FILL OIL LEVEL**, to do so may cause damage to the engine.

When checking oil refer to the engine manufacturers instructions for proper way to check the level. Some engines differ in the correct procedure.

Use 10W30 oil. Always check oil daily before using the machine.

 Be sure the carburetor air filter is free of dust/oil etc. Dirty air filters is the most frequent cause of elevated toxic emissions.

Check & clean recoil dust filter if necessary (see engine owners manual)

ADJUSTING HANDLE HEIGHT

The machine is equipped with an adjustable handle for comfort and use. Most find it necessary to adjust the handle to "belt height" for optimum control. A 9/16 wrench is used to loosen and tighten the pivot points..

INSTALLING THE FUEL CYLINDER

NOTE: For refueling cylinder see Page 11.

1. Take machine to a well ventilated area.
2. Check cylinder for overfill. (See page 11)
3. Install cylinder on machine with tank strap.
4. Connect the fuel cylinder to the machine using the "Rego" connection. Tighten "hand-tight". (Be careful not to cross thread the Rego connection)
5. Open the service valve slowly. Be alert for propane leaks.
6. To remove cylinder reverse procedure.

INSTALLING OR REMOVING PAD DRIVER AND PADS

Consult an authorized distributor to assist you in selecting the correct pad for your specific needs.

Pad driver installation:

1. Tip machine on the right side (dip stick down).
2. Place pad driver on drive shaft and spin pad driver clockwise to install.

Pad Removal & Installation:

1. Tilt machine back on rear caster or service position.
2. Remove center-lock from pad driver.
3. Remove pad from pad holder.
4. Center new pad on pad driver & secure with center-lock ring.

Pad Driver Removal:

1. Apply down pressure on bell of machine deck.
2. Use 3/4" open end wrench on top of drive shaft exposed on top of deck.
3. Strike the wrench with rubber mallet to break loose the shaft from the pad driver. (Counterclockwise)
4. Remove pad driver by spinning it off counterclockwise.

OPERATION

MACHINE OPERATION

 **FOR SAFETY: do not operate the machine until you have read & understood this manual.**

STARTING MACHINE:

1. Check the fuel cylinder for overfill. (See page 11)
 2. Install cylinder on the machine (See page 5).
 3. Place machine on level surface and check for correct oil level.
 4. Tilt machine back on rear caster.
 5. *Slowly* open the service valve on the fuel cylinder.
- NOTE: Opening** the service valve too quickly may cause the excess flow valve to stop the flow of propane. If this occurs, close the service valve, wait a few seconds and re-open it **SLOWLY!**

NOTE: some models have 110 volt starting, in this case it is necessary to use the short cord supplied with the machine. Use the necessary precautions when using electricity.

6. Push the throttle lever to the choke position and engage the starter. (Either by using the start button or by turning the key switch to start if equipped). Do not engage starter for more than 20 seconds at a time, allowing 10-20 seconds between attempts to start the engine.
7. When engine starts, ease the throttle back to running position.

 **NOTE: Do not run engine with throttle in the choke position! Excessive harmful emissions will be produced putting you and others in harms way!**

8. Increase throttle to about 3/4 and carefully lower the machine pad to the floor while walking forward slowly.

OPERATING THE ELECTRIC CLUTCH

If equipped with an optional clutch. Move throttle to slow and engage the clutch by squeezing the "trigger switch" on the operation handle. Move the throttle to 3/4 speed, slowly lower the pad to the floor while walking forward slowly,

CAUTION: Never engage clutch in the fast run position or with the pad on the floor, this may cause damage to the clutch and the floor!

 **WARNING! Be careful not to allow the machine to come in contact with loose tiles or other obstruction on the floor. The pad is turning at approximately 2000 RPM. If loose objects are hit by the revolving pad they could become dangerous missiles.**

OPERATING THE TRACKER 3000 MODEL STRIPPING MACHINE

ATTENTION: This machine is only as fast as you allow it to be. It is imperative that you keep the floor wet with stripping solution while stripping and remove the sludge quickly and completely. Rinsing thoroughly before recoating with sealer or floor finish.

1. Clear area of all displays. Remove any dust and stickers from floor.
2. Prepare stripping solution according to instructions on the label.
3. Apply solution to the floor using a mop or other method of application. **KEEP FLOOR WET WITH SOLUTION!**
4. Allow 10 minutes or so for solution to penetrate floor coating.
5. Using a "doodle bug" scrape the edges clear of floor finish.
6. Begin stripping with the machine (one pass is generally all that is needed).

7. Follow the machine with the recovery of the sludge and damp mop floor.

NOTE: *Rinse floor thoroughly!*

OPERATING THE DUST CONTROL MODEL

For best results the dust control skirt should be set 1/4" off the floor.

Dust is collected in cloth bag inside the deck enclosure. Do not operate the machine without a bag attached to the dust receptacle.

Remove and empty the bag as frequently as needed. Shake or vacuum the bag before reinstallation.

OPERATING THE EASY GLOSS SPRAY SYSTEM (OPTIONAL)

The Easy Gloss Spray System is used to clean, shine and maintain all floors with a simple two step process.

1. Install a clean cleaning pad on the machine.
2. Mix Easy Gloss Solution according to instructions on the label.
3. Fill container on the machine with solution.
4. Dust mop area to be cleaned.
5. Start the machine and set the throttle lever to MEDIUM speed.

6. Pull easy gloss trigger to apply solution. Once the solution reaches the floor, move the machine forward at a slow pace. At intervals of every fourth step, pull the trigger and hold for about 2 seconds.

NOTE: If too much solution is applied the wheels will leave a track, and if too little the floor will not be cleaned.

7. While applying solution, stay about 3" away from edges.

NOTE: *Remove and clean pad every time you refill the solution tank.*

8. When the cleaning process is complete, remove the cleaning pad and replace it with a fine polishing pad.

9. Restart the machine, set the throttle at medium high speed and buff the entire floor to a deep shine.

NOTE: *If pad overloads and leaves marks on the floor, stop buffing and clean the pad. It may be necessary to use a weaker solution mix.*

The Easy Gloss System is a preventive maintenance procedure, it does not replace scrubbing and finishing.

STOPPING THE MACHINE

1. Close the service valve on the fuel cylinder while the engine is running. This serves to "purge" the fuel system of all flammable gas.
2. Tilt the machine back on its rear caster and allow the engine to run until it stops.
3. Turn the key switch OFF if equipped.

EMERGENCY STOPPING

In case of an emergency the machine can be brought to an instant stop by:

1. Pull the throttle back to stop position or turn key switch to OFF if equipped.
2. Close service valve on the fuel cylinder.

NOTE: *The engine may backfire when stopped in this manner.*

3. If the machine is equipped with a "KILL SWITCH", activate the switch.

WHILE OPERATING THE MACHINE

 **WARNING:** Exhaust emissions contain harmful toxic gasses. The worst being carbon monoxide. Do not operate the machine in confined areas for prolonged times. Always make certain that adequate ventilation is had.

1. Refer to "SAFETY PRECAUTIONS" on page 4 and the *Safety Awareness Manual*.
2. Keep machine moving. Running in one place more than a few seconds may damage the floor.

OPERATION

3. Do not leave the machine unattended while the engine is running for long periods of time. If necessary to leave the machine for short periods to move a display etc. move the throttle lever to idle position and tip machine back on the rear caster.

⚠ ATTENTION: It is possible to damage the engine by allowing it to idle for long periods of time by affecting proper lubrication.

4. It has been the accepted practice to start buffing from the right side of the aisles. Most smaller machines are offset to the right to allow buffing close on that side.

CONVERTING THE PRIDE 2100 MODEL (STRIP BUFFER)

Tools Required:

1. 5/8" (16mm) & 3/4" (19mm) open end wrench
2. 9/16" wrench
3. 15/16" (24mm) deep-well socket & ratchet
4. Belt tensioner wrench (provided with machine).
5. Rubber mallet.

CONVERTING FROM BUFF TO STRIP MODE

1. With machine upright on the floor, loosen mounting bolt of belt tensioner on top side of machine deck. (See fig. 8-1)

2. Apply downward pressure with knee on bell of deck.

3. Remove pad driver (See page 5)

4. Remove short belt (BX 40) from upper set of pulleys (small pulley).

5. Replace with long belt (BX 52) for strip mode. Belt must be placed on lower pulleys (larger pulleys).

6. Using belt tensioner wrench provided, tension belt until 1/2" slack in belt on long side. Retighten mounting bolt on top side of deck.

7. Replace pad driver with stripping pad or attach optional brush and turn machine upright.

CONVERTING FROM STRIP TO BUFF MODE

1. Repeat steps 1 & 2 above.

2. Remove long belt (BX 52) from lower pulleys (large pulleys)

3. Replace with short belt (BX 40) for buffing mode. Belt must be placed on upper pulleys (small pulleys).

4. Complete steps 5 - 7 from above.

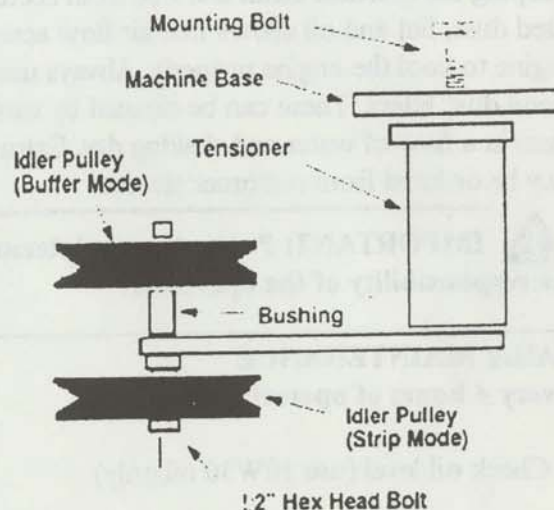

(fig. 8 - 1)

MAINTENANCE

! WARNING: Before attempting any maintenance procedures on the machine, close the service valve on the fuel tank and stop the engine.

! Repairs and adjustments to the fuel system must be made by an authorized, properly trained service technician.

To keep the machine in good working condition, simply follow the daily, weekly, and monthly maintenance procedures.

Keeping the machine clean and free from accumulated dust, lint and oil allows free air flow across the engine to cool the engine properly. Always use clean recoil dust filters. These can be cleaned by washing them in a flow of water and shaking dry. Extra filters may be ordered from customer service.

! IMPORTANT: Preventive maintenance is the responsibility of the operator!

**DAILY MAINTENANCE
(every 4 hours of operation)**

1. Check oil level (use 10W30 oil only)
2. Clean recoil filter.
3. Check & clean carburetor air filter.
4. Check belt tension by pinching belt together. Belt should deflect only 1/2" (13mm).
5. Make sure all components are secure and tight, (pad holder, fuel cylinder etc.)
6. Check pad holder and pad daily (clean or replace)
7. Clean machine, if compressed air is available blow dust from machine and engine, concentrating on the inside of engine shrouds. Wash undercarriage.
8. On dust collection units, clean dust collection bag.

**WEEKLY MAINTENANCE
(every 20 hours of operation)**

1. All checks made on a daily basis plus:
 2. Change oil and oil filters at 50 hours of service. Use 10W30 Motor Oil or other no ash motor oils designed for use in propane engines. Use of non-recommended oil may void the engine warranty. (See engine manual supplied with documentation).
 3. Check for loose nuts and/or bolts on entire machine
 4. Examine all propane fuel components for leaks or wear. Replace if necessary.
 5. Grease wheels. Use white lithium grease only and no more than 1 pump of grease. More grease than recommended will push the seals and dust covers out, allowing dust and other foreign materials to penetrate the bearing, shortening the life of the bearings as well as allowing grease to drop from wheels to the floor.

**MONTHLY MAINTENANCE
(every 80 hours of operation)**

1. Perform all daily and weekly services.

Consult engine owners manual for the following:

2. Torque head bolts.
3. Check valve clearance.
4. Torque valve cover bolts.
5. Inspect spark plug. Repace if necessary.
6. Remove engine shroud and clean cooling fins.

**QUARTERLY MAINTENANCE
(EVERY 250 HOURS OF OPERATION)**

1. Perform all of the monthly maintenance items.
2. Have engine serviced by Authorized Service Center. Including emissions check.

OPERATION

Maintenance Continued:

LIFE TIME OF MACHINE:

1. Change oil regularly.
2. Clean recoil filter regularly.
3. Clean carburetor air filter regularly.
4. Keep machine clean from dust, oil, and debris.
5. Keep a log book of maintenance and repairs.

PROPANE FUEL SYSTEM

! Adjustments and repairs to the propane fuel system can only be made by properly trained and certified Service Technicians!

! Improper adjustments will cause increased toxic emissions of carbon monoxide and may result in carbon monoxide poisoning.

HANGING OIL

The manufacturer recommends 10W30 oil.

1. Run engine for 5 minutes to warm the oil.
2. Make sure machine is on a level surface, pad on the floor. Place container under drain and open the oil drain valve. Allow oil to drain completely.
3. Close drain valve and add 1 qt. of 10W30 Motor Oil. Check level and add if necessary.
4. Replace oil-fill cap assembly. Hand tighten only.

ATTENTION: Do not over fill oil and never run engine with low oil level.

NOTE: When checking oil, remove dip stick, wipe clean, then reinsert the dip stick into the engine, **DO NOT SCREW IN**, remove dip stick and observe oil level as indicated on the dip stick.

NOTE: Some engines require the dip stick to be screwed in for accurate readings. Check the engine manual supplied with your machine for the recommended procedure.

ADJUSTING BELT TENSION

(See fig. 10-1)

Tools required:

- 3/4" (19mm) open end wrench
- 15/16" (24mm) deep-well socket

1. Loosen Mounting Bolt on top side of machine deck while holding adjusting nut on underside of deck.

NOTE: The mounting bolt must be loosened before adjustment can be made.

2. Rotate adjusting nut counter clockwise with socket to apply tension to belt.

3. While holding the tension on the adjusting nut, tighten the mounting bolt on the top of the deck.

4. Check belt tension by pinching belt together. Belt should depress only 1/2" (12mm)

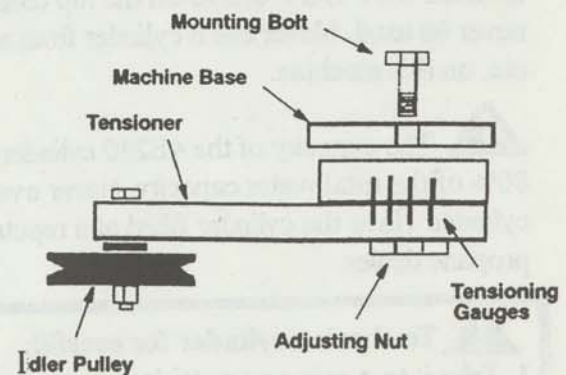

(fig. 10-1)

REFUELING AND STORING CYLINDERS

The following information refers to regulations within the United States of America and Canada. For other Countries the owner must assure that the required regulations are met.

National Fire Protection Association (NFPA) has established standards for the Storage and Handling of Liquefied Petroleum Gasses. This standard is NFPA 58.

Liquefied propane will expand 270 times into flammable vapor, which is used as fuel for propane engines. Proper training is recommended for those operating propane powered machines in order to limit the hazards related to the handling and storage of propane fuel cylinders. (See the "Safety Awareness Manual" included with the documentation shipped with this machine). **If you do not have a copy of this document call Customer Service at 1-800-633-0519 for a free copy.**

REFILLING PROPANE CYLINDERS

 The fuel cylinder supplied with this machine is a DOT 4E240 propane cylinder. Cylinders not branded with DOT 4E240 on the top collar should never be used. Never use a cylinder from a barbecue etc. on this machine.

 The capacity of the 4E240 cylinder is 20#, 80% of the total water capacity. Never overfill the cylinder. Have the cylinder filled at a reputable propane dealer.

 **To check a cylinder for overfill:**

1. Take it to a safe area outside
2. Open the fixed liquid level gauge. (bleeder valve)
3. Observe the gas from the valve:
 If white cloud, overfilled!
 If clear vapor, safe!
4. If overfilled, allow to vent until vapor is clear.

Do not attempt to repair a propane cylinder yourself. Return the cylinder to your propane vendor for authorized service.

STORING FUEL CYLINDERS

 **ATTENTION:** Propane fuel cylinders whether full or empty should be stored outside the building in a secure cylinder storage cabinet in accordance with NFPA 58 5-4.2.1

 **CAUTION:** Vertical propane fuel cylinders must always be stored in a vertical position. This position assures that the discharge from the pressure relief valve or other items will be largely vapor and not liquid which will expand to 270 times to flammable vapor.

The manufacturer reminds you that the fuel cylinders should be removed from the machine and placed in the proper storage cabinets outside the building.

NOTE: Local Authorities may have additional requirements for storage of fuel cylinders. Always check with the local Authorities!

STORING THE MACHINE

1. Remove the propane cylinder and store outside as above.
2. Perform all daily maintenance procedures.
3. Store machine in a cool, dry, secure area where it will not be damaged by other traffic.
4. Tilt the machine back on the rear caster with the pad off of the floor.

TRANSPORTING THE MACHINE

When transporting the machine from one job to another secure the machine in your truck or van with the fuel cylinder installed and the service valve OFF!

Allow the engine to cool down some before loading it.

OPERATION

TROUBLE SHOOTING GUIDE		
PROBLEM	CAUSE	SOLUTION
Will not start	No fuel or dirt in fuel line Blown head gasket Engine overload Dirty air cleaner Faulty spark plug Fuel susyem out of adjustment Defective ignition coil	See engine owners manual for servicing. NOTE: only properly trained service technicians should adjust or repair fuel system!
Hard to start	No fuel or dirt in fuel line Engine overload Dirty air cleaner Faulty spark plug Spark plug or head bolts loose Blown head gasket Timing, coil or valves need adjustment Regulator need adjustment Insufficient vacuum	See engine owners manual for servicing. NOTE: only properly trained service technicians should adjust or repair fuel system!
Lacks power	Improper valve clearance Dirt in fuel line Faulty spark plug Improper oil level Worn rings	See engine owners manual for servicing. NOTE: only properly trained service technicians should adjust or repair fuel system!
Odor of burned rubber	Belt out of adjustment	See "Adjusting Belt Tension"
Engine overheats	Incorrect oil level Engine overload Build up of dirt inside engine shroud	See engine owners manual for servicing.
High fuel consumption	Faulty spark plug Dirty air cleaners Improper fuel system adjustment	See engine owners manual for servicing. NOTE: only properly trained service technicians should adjust or repair fuel system!
Machine stops suddenly	Out of fuel	Change fuel cylinders
	Faulty spark plug	Clean adjust or replace spark plug
	Pad not centered on pad driver	Center pad on pad holder
	Incorrect pad size	Replace with proper pad
	Low oil	Add oil (see page 9)
Excess vibration	Bolts loose on engine or deck	Tighten all bolts
	Pad not centered or damaged pad	Center or replace pad
	Incorrect oil level	Check and adjust oil level
	Engine overload	See engine owners manual for servicing.
	Dirty filters	
	Faulty spark plug	